

---

# Recommended Operations

Recommended Command Order .....	R-4
Set the Printing Area .....	R-5
The printable area .....	R-6
Setting left and right margins.....	R-9
Setting page length.....	R-10
Setting top and bottom margins.....	R-13
Setting bottom margin.....	R-13
Select Characters .....	R-15
Assign character tables.....	R-15
Defining user-defined characters .....	R-17
Planning user-defined characters.....	R-19
Setting user-defined character traits .....	R-22
Copying ROM characters to RAM memory.....	R-24
Storing user-defined character data in printer memory.....	R-25
Switching to RAM character printing.....	R-36
Selecting an international character set .....	R-41
Select a Font .....	R-42
Print quality (draft, LQ, or NLQ) .....	R-43
Standard and scalable fonts (multipoint mode).....	R-43
Selecting the character table .....	R-44
Selecting the point size .....	R-45
Selecting the typeface .....	R-47
Selecting the pitch .....	R-48
Selecting the style.....	R-50
Selecting the weight.....	R-51
Enhancements .....	R-51
Double-strike .....	R-51
Shadow/outline .....	R-52
Score .....	R-53
Super/subscript .....	R-54
Select Supporting Features .....	R-55
Selecting unidirectional print head movement .....	R-55
Selecting print color.....	R-55
Select the Print Position .....	R-56
Moving the horizontal position .....	R-57
Moving the vertical position .....	R-60
Send Print Data.....	R-64

Sending Graphics Data.....	R-65
Bit-image graphics .....	R-66
Mixing text and bit-image graphics with ESC/P 2 printers .....	R-71
Graphics mode .....	R-73
Standard raster graphics .....	R-74
Extended raster graphics (ESC . 2) .....	R-83
Printing Bar Codes.....	R-84
Extended ESC/P 2 Programming Guide.....	R-99
MicroWeave technology.....	R-99
Monochrome printing support .....	R-100
Color bit-image graphics support.....	R-100
ESC/P 2 color multipoint font support .....	R-100
ESC/P 2 MicroWeave color raster graphics and RLE compressed raster graphics.....	R-101
ESC/P 2 MicroWeave color extended raster graphics—TIFF.....	R-101
Programming examples .....	R-104
Example 1: ESC/P 2 color multipoint font driver.....	R-104
Example 2: MicroWeave ESC/P 2 standard color raster graphics and RLE compressed raster graphics driver.....	R-105
Example 3: MicroWeave ESC/P 2 extended color raster graphics and TIFF compressed raster graphics driver.....	R-107

This section describes the recommended method and order of performing operations on an EPSON dot matrix printer. An outline of recommended operation order is provided first, followed by detailed explanations of each operation.

Basic recommendations are provided for printers featuring ESC/P 2. You should follow these recommendations if you are writing programs for ESC/P 2 printers.

In addition, this section provides information on newly added ESC/P 2 commands, known as extended ESC/P 2, as well as programming examples for EPSON's high-resolution (up to 720 by 720 dpi) color printer models.

Where necessary, additional explanations are included for 24/48-pin printers at previous ESC/P levels, as well as for 9-pin printers. Although ESC/P 2 printers can operate using software written for earlier printers (if deleted and nonrecommended commands are avoided), you should use the ESC/P 2 level explanations to take full advantage of advanced ESC/P 2 features.

## *Recommended Command Order*

Because some command results change based on the settings made with other commands, you should send commands and data in the order described in this section.

Once you set the printing area and page length, send data line by line from top to bottom of each page. The printer can handle data most efficiently when received in this order (although commands can move the vertical print position both up and down on a page). The exception to this rule is when printing bit-image graphics and characters on the same line, as described in “Mixing text and bit-image graphics.”

The following order is applicable to all ESC/P levels.

1. Send an ESC @ command to initialize the printer.
2. Set the unit of line spacing to the minimum vertical increment necessary.
3. Set the printing area.
4. Assign character tables to each of the four active tables as necessary (ESC/P 2 printers only).
5. Define any user-defined characters.
6. Select the font.
7. Set supporting features.
8. Set the print position.
9. Send one line's print data.
10. End the line of data with a CR and LF command.
11. Repeat steps 6 to 10 as necessary for each following line on the page.
12. End the page with a FF command.
13. Repeat steps 6 to 12 as necessary for each following page (always send a FF command after the final page also).
14. End printing by sending the ESC @ command.

See the following sections in this chapter for additional information on the above steps.



## The printable area

ESC/P 2

ESC/P

9-Pin ESC/P

The printable area for continuous and single-sheet paper is shown below.

Single sheets (also envelopes and  
single-type multipart forms)

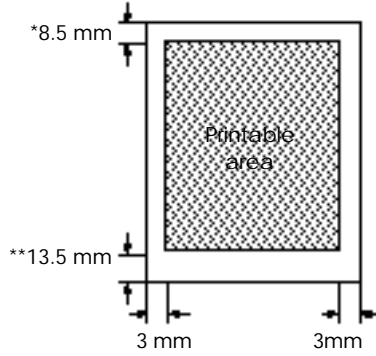

Continuous paper

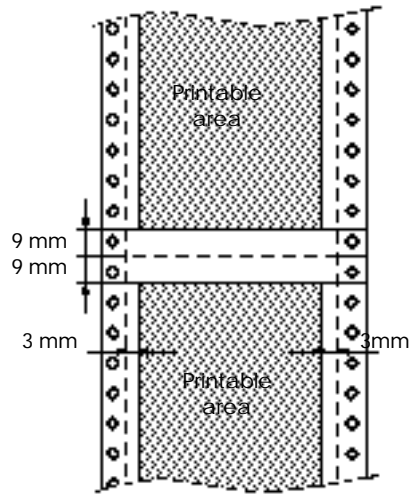

\*, \*\* The nonprintable area varies  
on some printer models.  
(See Feature Summary for  
details.)

### Note:

- Make sure your program keeps printing within this area; otherwise, print quality cannot be assured.
- Make sure the margins stay within the printable area. The area within these margins is called the printing area.

The following diagram shows the printing area for single-sheet and continuous paper.

ESC/P 2

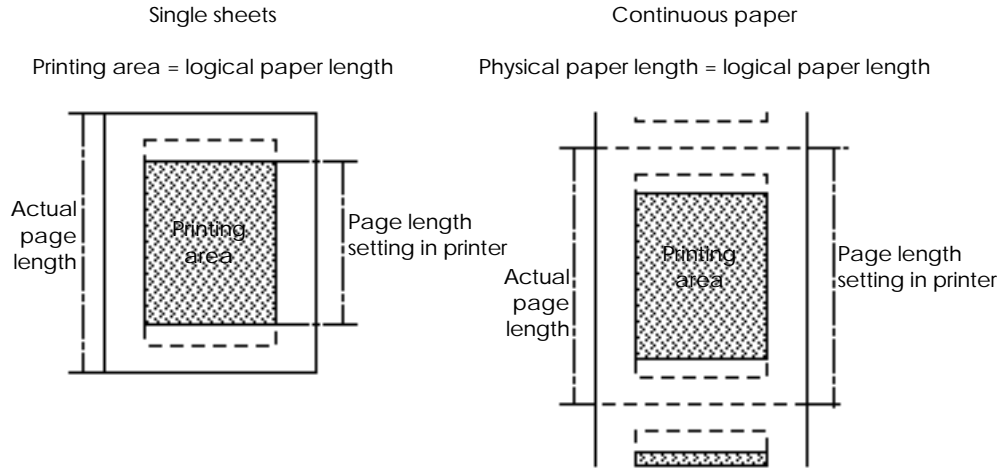

ESC/P 9-Pin ESC/P

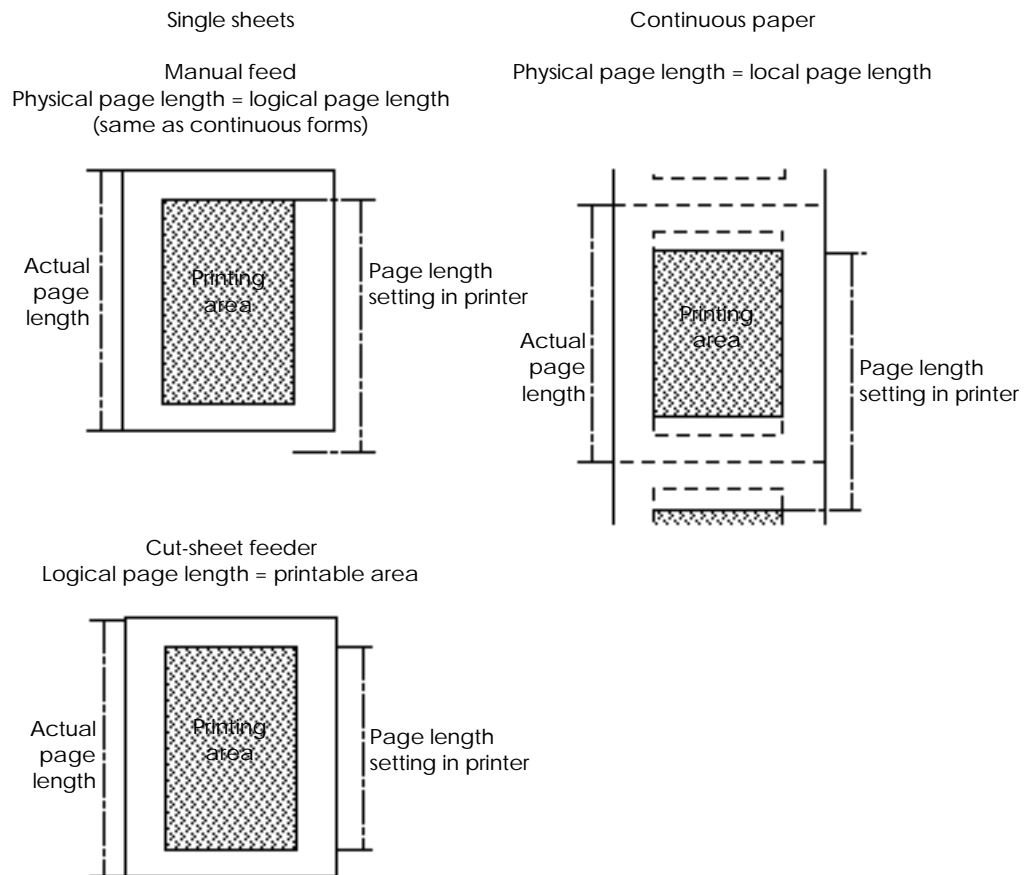

The printing area in ESC/P 2 differs for text and graphics printing.

If the point size is larger than 10.5 points, and the print position is near the top or bottom-margin position, part of the character may print outside the printing area (above the top-margin or below the bottom-margin). The printer prints the full character, even though it falls outside the printing area, with the following exception:

If part of the character falls outside the printable area on single-sheet paper (closer than 8.5 mm to the top edge or closer than 13.5 mm to the bottom edge), printing of that part is not assured.

When setting the vertical print position, you must place enough room at the top and bottom of a page for a full character to print.

The following diagram illustrates the differences between graphics and character printing areas near the top and bottom-margin positions.

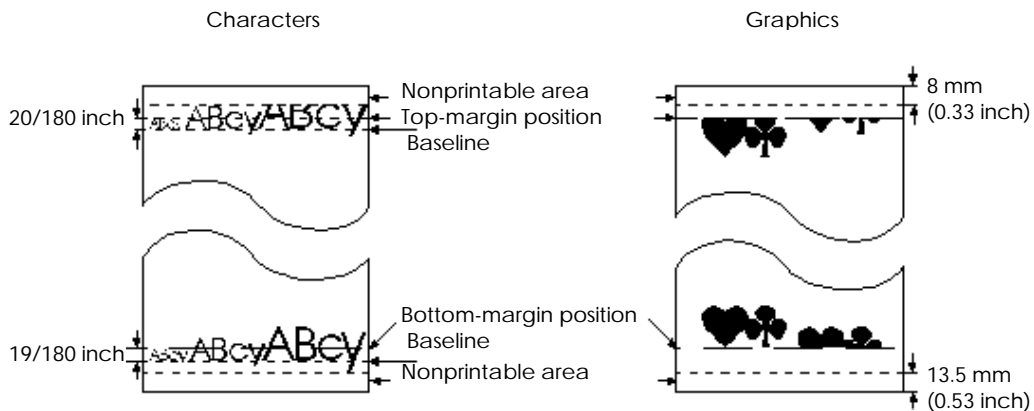

**Note:**

- You can print characters outside the top and bottom-margin positions as long as the vertical print position is within the printing area. However, character printing within the nonprintable area is not assured; parts of characters may be cut off.
- You cannot print any part of graphics outside the top and bottom-margin positions.

## Setting left and right margins

ESC/P 2

ESC/P

9-Pin ESC/P

Use the ESC I command to set the left margin and the ESC Q command to set the right. The format of these commands is as follows:

ESC I m  
ESC Q m

The m parameter equals the number of characters from the left-most mechanically printable position, in the current character pitch.

The following commands affect the character pitch (see individual commands in the Command Summary for details):

ESC P	Selects 1/10-inch character width (10 cpi)
ESC M	Selects 1/12-inch character width (12 cpi)
ESC g	Selects 1/15-inch character width (15 cpi)
ESC W 1	Doubles the current character width
ESC p 1	Selects proportional spacing. When setting the margins, the character width is considered to be 1/10 inch
ESC SP n	Adds extra space between each character (n/180 inch for LQ characters and n/120 inch for draft characters on 24/48-pin printers; n/120 inch on 9-pin printers). The resulting character width is:

(current character width) = (previous character width) + (extra space)

SI	Selects condensed printing, resulting in the following character widths:  1/17 inch if 10-cpi is currently selected 1/20 inch if 12-cpi is currently selected
ESC c	Sets the character pitch to between 1/360 and 3 inches (available only on ESC/P 2 printers)
ESC X	Sets pitch and point of scalable fonts (available only on ESC/P 2 printers).

### **Note:**

- Once the margins are set, changing the character width does not affect the margins.

- The margins must be set at the beginning of the line (before any printable data is sent); otherwise, the printer ignores any data preceding these commands.
- Always set pitch before setting left and right margins. Do not assume what the pitch setting will be.

The diagram below shows the margins set by sending the following commands when 8 1/2-inch wide paper is used and the left edge of the paper is at the left-most mechanically printable position.

ESC @	Resets printer settings
ESC P	Selects 10-cpi printing (character width of 1/10 inch)
ESC l 10	Sets a 1-inch left margin
ESC Q 75	Sets a 1-inch right margin

Margin diagram

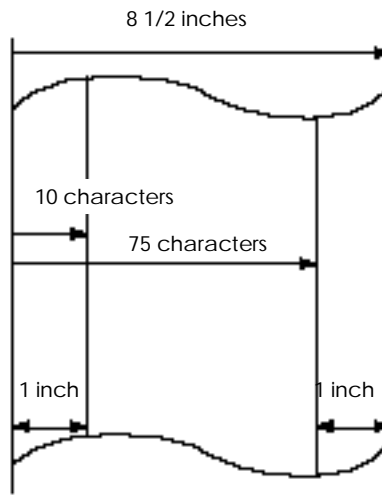

### Setting page length

Because the method of page handling is different, the method for setting the page length differs for ESC/P 2 and previous ESC/P versions. This section explains both methods.

#### ESC/P 2

The ESC/P 2 method of setting the page length allows you to use the same program for both single-sheet and continuous paper.

The page length setting is effective only when you are using continuous paper. However, since the printer ignores the setting during single-sheet printing, the printer is always ready to print on either type of paper.

For single sheets, the printer calculates the page length as the distance between the top and bottom margins.

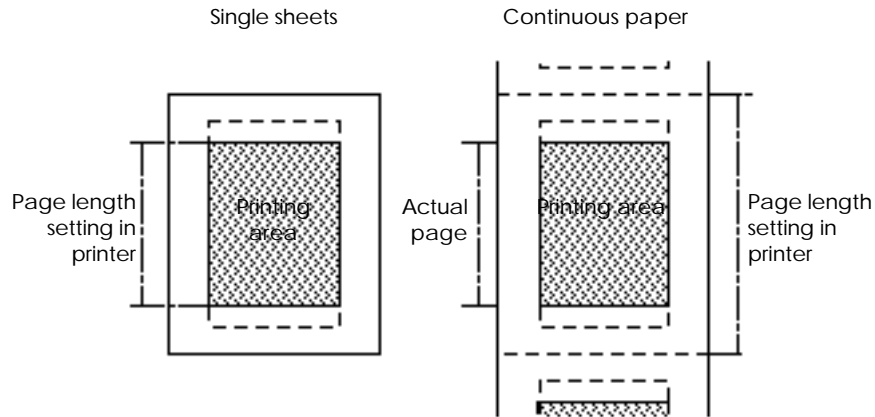

Also, to simplify movement of the horizontal and vertical print position, ESC/P 2 provides the ESC ( U command for setting the unit of movement and measurement. The page length is set with the ESC ( C command, based on this unit.

Always set the unit before setting the page length. The unit can be set as small as 1/360 inch; set the unit to the minimum size necessary for vertical and horizontal movement within the current print job.

**Note:**

- Always set the page length before paper is loaded or when the print position is at the top-of-form position. Otherwise, the current print position becomes the top-of-form position, results in undesirable contradictions between the actual and logical page settings.
- Setting the page length cancels any previously set top or bottom margins.
- The maximum page length is 22 inches.
- Changing the unit after the page length has been set does not affect the page length.

The following commands set the page length to 11 inches, based on a unit of 1/360 inch.

ESC ( U 1 0 10                      Sets a unit of 1/360 inch

ESC ( C 2 0 120 15                Selects a page length of 11 inches (3,960 units)

For non-ESC/p 2 printers, set the page length with the following commands:

ESC C	Sets the page length in lines, according to the currentline spacing
ESC C NUL	Sets the page length in 1-inch increments

To set the page length in lines, you must first set the line spacing. The maximum number of lines you can set with the ESC C command is 127.

Use the following commands to set the line spacing:

ESC 2	Selects 1/6-inch line spacing
ESC 0	Selects 1/8-inch line spacing
ESC + n	Selects n/360-inch line spacing (24/48-pin printers only)
ESC 3 n	Selects n/180-inch line spacing (24/48-pin printers)Selects n/216-inch line spacing (9-pin printers)

**Note:**

- Always set the page length before paper is loaded or when the print position is at the top-of-form position. Otherwise, the current print position becomes the top-of-form position, which results in undesirable contradictions between the actual and logical page settings.
- Setting the page length cancels any previously set bottom margin.
- The maximum page length is 22 inches.
- Changing the line spacing after the page length has been set does not affect the page length.
- Always set the line spacing before setting the page length with the ESC C command. Do not assume what the line spacing will be.

The following commands select 1/6-inch line spacing and a page length of 11 inches (66 lines).

ESC 2	Selects 1/6-inch line spacing
ESC C 66	Sets a page length of 11 inches (66 lines)

The following command also selects a page length of 11 inches.

ESC C NUL 11	Sets a page length of 11 inches
--------------	---------------------------------

## Setting top and bottom margins

ESC/P 2

ESC/P 2 provides the ESC ( c command for setting both top and bottom margins. This allows the printing area settings to match the actual paper.

The top and bottom margin settings are based on the unit defined with the ESC ( U command. If using continuous paper, you should have already defined this unit when you set the page length with the ESC ( c command. If not, see the description of the ESC ( U command in the Command Summary and “Setting the page length” in this section.

### **Note:**

- Measure top and bottom margins from the top edge of the page.
- The distance from the top edge of the page to the bottom-margin position must be less than the page length; otherwise, the end of the page length becomes the bottom-margin position.
- Setting the top and bottom margins cancels previous top or bottom-margin settings.
- Changing the defined unit does not affect previously set top and bottom-margin settings.
- Always set the top and bottom margins before paper is loaded or when the print position is at the top-of-form position. Otherwise, the current print position becomes the top-of-form position (this results in undesirable contradictions between the actual and logical page settings).

The following command sets a top and bottom margin of 1 inch when the unit is defined as 1/360 inch and 8 1/2 by 11-inch paper is used.

ESC ( c 4 0 104 1 16 14 Sets a top margin of 1 inch (360 units) and a bottom margin 10 inches (3,600 units) below the paper's top edge.

## Setting bottom margin

ESC/P

9-Pin ESC/P

When using continuous paper on non-ESC/P 2 printers, set the bottom margin with the ESC N command. The printer then automatically moves the print position to the top-of-form position of the next page when it receives a FF command, or when the print position moves below the bottom-margin position.

The ESC N command sets the bottom margin in lines above the top-of-form position of the following page; you must first set the line spacing.

Use one of the following commands to set the line spacing:

ESC 2	Selects 1/6-inch line spacing
ESC 0	Selects 1/8-inch line spacing
ESC + n	Selects n/360-inch line spacing (24/48-pin printers only)
ESC 3 n	Selects n/180-inch line spacing (24/48-pin printers)Selects n/216-inch line spacing (9-pin printers)

**Note:**

- Sending the ESC N command cancels any previous top or bottom margin setting.
- The bottom margin set with the ESC N command is ignored when printing on single sheets.
- Avoid using this command with ESC/P 2 printers. By using ESC/P 2's ESC ( c command instead, the bottom margin is effective for both single-sheet and continuous paper.
- The distance from the top edge of the page to the bottom-margin position must be less than the page length.
- Use the ESC O command to cancel the bottom margin.
- Always set the line spacing before setting the bottom margin with the ESC N command. Do not assume what the line spacing setting will be.

The following commands set a bottom margin of 1 inch when 8 1/2 by 11-inch paper is used (assuming the top-of-form position is at the perforation between pages).

ESC 2	Selects 1/6-inch line spacing
ESC N 6	Sets a bottom margin 1 inch (6 lines) above the next page's top-of-form position.

## Select Characters

ESC/P 2

ESC/P

9-Pin ESC/P

Character size and variation have been greatly increased in ESC/P 2. In addition to the basic 10.5-point characters and enhancements available in previous ESC/P versions, scalable font capability allows for the selection of fonts based on point size and five other font attributes. Point size can be selected from 8 to 32 points, in two-point increments.

Also, an increased number of built-in character tables allows access to characters and symbols not previously available.

The following sections explain how to select characters on all EPSON printers. Differences between ESC/P 2 and previous ESC/P versions are explained when necessary.

To select characters, follow the command order outlined below:

1. Use the ESC ( t command to assign character tables you plan to use to one of the four active tables selectable with the ESC t command (ESC/P 2 printers only).
2. Define any user-defined (download) characters you plan to use.
3. Select the international character set you plan to use.

By making all the above settings, you have defined the initial characters. See the following sections for details on making each of these settings.

### Assign character tables

ESC/P 2

On ESC/P 2 printers, a greater variety of characters is available because of an increased number of built-in character tables.

Previous versions of ESC/P allowed selection of an italics and graphics character table with the ESC t command. ESC/P 2 has expanded on this by allowing access to four active character tables with the ESC t command. Also, you can assign any of the numerous built-in (registered) character tables to these four active tables.

The ESC/P 2 command for assigning these tables is ESC ( t. The diagram below illustrates this process.

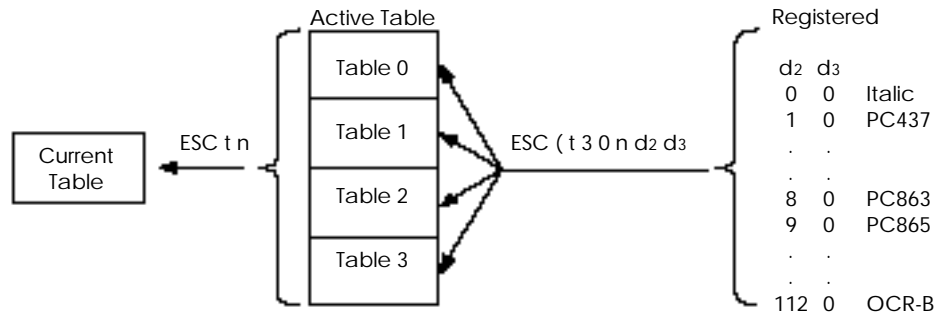

**Note:**

- You always assign the tables at the beginning of a print job; do not assume what the settings are.
- You can reassign any of the tables at any time, without affecting other table assignments.
- Do not assign a registered table to Table 2 if you plan to use it for user-defined characters. Once you assign a registered table to Table 2, you must reset the printer (with the ESC @ command) before you can use it for user-defined characters.

The following commands assign character tables to active tables 0 to 3.

- |                   |  |
|-------------------|--|
| ESC ( t 3 0 0 0 0 | Assigns the italic table to active Table 0.                |
| ESC ( t 3 0 1 1 0 | Assigns the PC437 (US) table to active Table 1.            |
| ESC ( t 3 0 2 8 0 | Assigns the PC865 (Canada-French) Table to active Table 2. |
| ESC ( t 3 0 3 3 0 | Assigns the PC850 (Multilingual) table to active Table 3.  |

## Defining user-defined characters

ESC/P 2

ESC/P

9-Pin ESC/P

With the user-defined character function you can design your own characters and save them in the printer's memory for repeated use in a print job.

The printer has two types of character memory: ROM and RAM. The printer stores its built-in character sets in ROM memory; you cannot modify ROM memory. You can modify RAM memory, however, in two ways: you can copy characters from ROM memory and you can save user-defined characters.

The general method of defining characters (sometimes called downloading) is basically the same with all EPSON dot-matrix printers. However, the method of accessing user-defined characters depends on the ESC/P version. This section explains the basic process while describing the differences when necessary.

### **Note:**

You can only print user-defined characters as 10.5-point characters (or 21-point characters when double-height printing is selected). Even if you select a different point size with the ESC X command, characters in RAM can only be printed as 10.5 or 21-point characters.

The steps below should be followed to create user-defined characters.

- 1 Plan the data for your desired characters. The amount of data required depends on the following factors:
  - The number of dots in the print head (9 or 24/48)
  - The space you specify on the left and right of each character
  - Character spacing (10 cpi, 12 cpi, 15 cpi, or proportional)
  - The size of your characters (normal or super/subscript)
  - The print quality of your characters (draft, LQ, or NLQ mode)
- 2 Cancel italics with the ESC 5 command and set the following traits of the characters you plan to define:
  - Print quality
  - Size (either normal or super/subscript)—24/48-pin printers only
  - Proportional or fixed character spacing—24/48-pin printers only

- 3 The printer stores user-defined characters in RAM memory; you must tell the printer to find characters in RAM memory if you want to print user-defined characters. If you plan to use many of the standard characters along with your user-defined characters, use the ESC : command to copy the currently selected character table to the printer's RAM memory. This allows you to print user-defined characters without having to switch from ROM to RAM characters and back again each time.
- 4 Define and send the data to the printer's RAM memory using the ESC & command.
- 5 Switch to RAM characters. The printer then uses the user-defined characters when printing text.

**Note:**

- On 24/48-pin printers, you can use the ESC t 2 command to copy character data (including user-defined characters) from codes 0 to 127 to codes 128 to 255. This is desirable if you wish to print codes between 0 and 127 as usual while having access to user-defined characters.
- If you plan to use the ESC t 2 command to access user-defined characters on an ESC/P 2 printer, make sure you do not assign a registered character table to active Table 2 with the ESC ( t command. Once you have assigned a registered table to Table 2, you cannot use it for user-defined characters (until you reset the printer with the ESC @ command).

## Planning user-defined characters

ESC/P 2

ESC/P

9-Pin ESC/P

User-defined characters are defined based on a combination of several traits. This combination of traits determines the number of dots that can be defined (and the amount of data that must be sent) for each character.

These traits, and the maximum recommended size for each combination of traits is shown in the table below. Exceeding the width for the following fixed pitches may not allow for sufficient spacing between characters.

### 24/48-pin printers (*height · width*)

Traits		Recommended size
Draft	fixed-pitch	24 × 12 (10 cpi)
		24 × 10 (12 cpi)
		24 × 8 (15 cpi)
LQ	fixed-pitch	24 × 36 (10 cpi)
		24 × 30 (12 cpi)
		24 × 24 (15 cpi)
	proportional	24 × 37
	super/subscript	16 × 36 (10 cpi)
		16 × 30 (12 cpi)
		16 × 24 (15 cpi)
super/subscript, proportional	16 × 37	

### 9-pin printers (*height · width*)

Traits	Recommended size
Draft	8 × 11
NLQ	18 × 12

#### **Note:**

For 9-pin printers, NLQ user-defined characters are available only on LX-series printers.

The diagrams below show the planning grids for LQ, NLQ, and draft mode characters.

24/48-pin

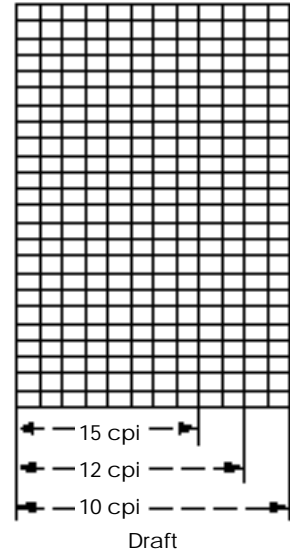
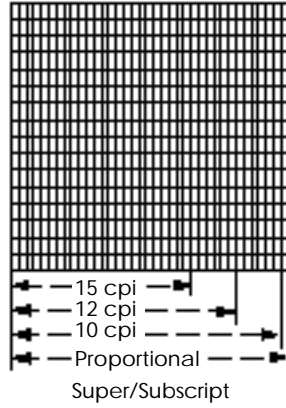
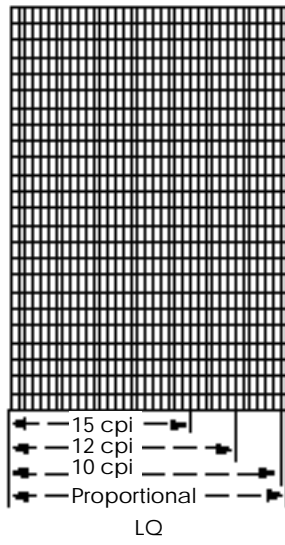

9-pin

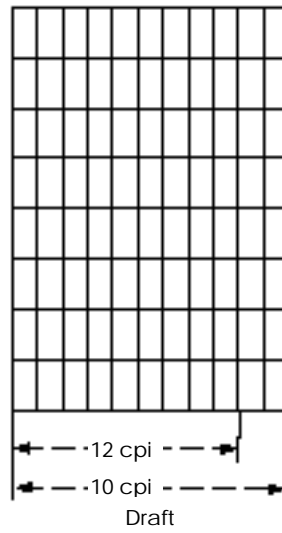
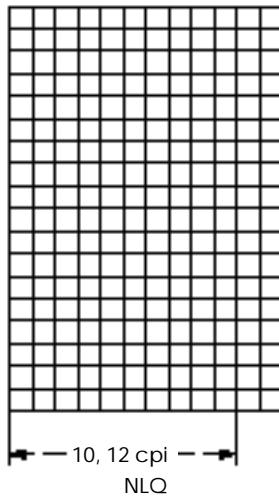

Follow the steps below to plan a user-defined character.

1. First determine the type of characters you wish to define (for example, 24-pin, LQ-mode, 12-cpi characters).
2. Consult the chart above for the maximum recommended dot-matrix size for your selected characters (the maximum for the example in step 1 is 24 dots high  $\times$  30 dots wide).
3. On the appropriate grid for your chosen character attributes, fill in the dots you wish to print to form your character. Keep the following restrictions in mind:
  - You cannot print consecutive horizontal dots on 24-pin printers, or in draft-mode on 9-pin printers. The printer ignores the second of any consecutive horizontal dots. For example, the printer ignores the dots circled below.

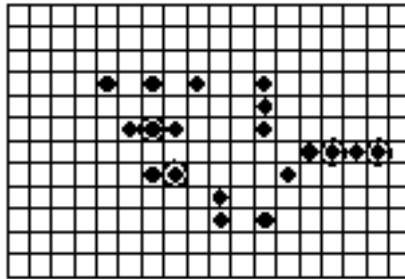

- If you are defining proportional, LQ characters on 24-pin printers, you need to define the space to the left and the right when you send the characters to the printer.
- In the built-in character sets the character baseline is as follows:

24-pin printers	Pin number 20
9-pin printers (draft)	Pin number 7
(NLQ)	Dot number 14 in the 18-dot column

## Setting user-defined character traits

Before you can define and save your user-defined characters, you must change the printer settings to match your planned characters. The following combinations of character traits are possible.

### 24 /48-pin printers

Print quality	Proportional	Fixed pitch
Draft		✓
LQ Normal size	✓	✓
Super/Subscript	✓	✓

### 9-Pin printers

Print quality	
Draft	✓
NLQ	✓

### **Note:**

You should not store characters in RAM memory when the printer is set to italic printing (with the ESC 4 command). Always send the ESC 5 command to cancel italic printing before you define user-defined characters or copy characters to RAM memory.

Follow the steps below when setting the traits of your planned user-defined and other RAM characters. (Only steps 1 and 2 are necessary for 9-pin printers.)

1. Select the print quality: LQ, NLQ, or draft.
2. Cancel italic printing.
3. Select or cancel proportional spacing.
4. Select or cancel super/subscript characters.

The following commands are used to select the traits for your planned characters.

ESC x 1	Selects LQ-mode or NLQ-mode
ESC x 0	Selects draft
ESC S 0	Selects superscript
ESC S 1	Selects subscript
ESC T	Cancel super/subscript
ESC 5	Cancel italic printing
ESC p 1	Selects proportional spacing
ESC p 0	Cancel proportional spacing

**Note:**

- Always set or cancel all attributes; don't assume what the current settings are.
- Once you have set the desired attributes, copy the ROM characters to RAM (if necessary) and define all user-defined characters before changing the attributes again. If you change the attributes and then define additional user-defined characters, the printer clears all characters previously in RAM memory.

## Copying ROM characters to RAM memory

ESC/P 2

ESC/P

9-Pin ESC/P

You must tell the printer where to find characters: either in the ROM memory (for built-in characters) or in the RAM memory (for user-defined characters). Each time you want to print a user-defined character, you must switch to RAM memory.

You may plan on using many of the standard characters along with your user-defined characters. If so, you can avoid having to switch between ROM and RAM memory each time by copying the characters from the printer's ROM memory to its RAM memory. The ESC : command performs this function.

When you send the ESC : command, the printer copies all the characters from locations 0 to 127 in the currently selected typeface to the same locations in RAM memory. You can then store your user-defined characters and still print all the other characters (except those you redefine) without having to switch back and forth between RAM and ROM memory each time.

Keep the following in mind when copying ROM characters to RAM memory.

- On some printers, you can specify which typeface to copy to RAM memory; see ESC : in the Command Summary and Command Table sections.
- You can only define 10.5-point characters. Even if you select a different point size with the ESC X command, characters in RAM can only be printed as 10.5-point characters (or as 21-point characters if double-height is selected).
- Sending the ESC : command erases any characters that are currently stored in RAM. Always copy ROM characters to RAM before you define user-defined characters. (You cannot copy ROM characters to RAM during multipoint mode.)
- The RAM memory can only store characters of one type at the same time. If you define subscript user-defined characters when normal height characters are stored in RAM memory, for example, the printer erases all previously stored characters. Always set the desired character traits before copying characters (both ROM and user-defined characters).
- Characters copied from ROM to RAM with the ESC : command must have the same traits as the user-defined characters you plan to define. If you define user-defined characters with different traits, the printer erases all previous characters in RAM memory.
- Defining user-defined characters clears any characters previously at that character code location.
- To print characters in RAM, you must first copy characters with the ESC : command or define characters with the ESC & command. The printer ignores commands that would print characters that have not been defined; nothing will be printed.

## Storing user-defined character data in printer memory

ESC/P 2

ESC/P

9-Pin ESC/P

Once you have set the necessary traits for your characters (and copied the ROM characters to RAM memory, if desired), you can define and store your user-defined characters.

The following sections cover 9 and 24/48-pin printers. Since the command format is different for 9-pin printers, the explanation in “Sending user-defined characters to the printer” is divided into a 24/48-pin section and a 9-pin section.

Follow the steps below to define user-defined characters.

1. Prepare the data for each character you wish to define (including space to the left and right of each character).
2. Decide where to store your user-defined characters in RAM memory.
3. Use the ESC & command to define the characters in RAM memory.

### Preparing data

1. First divide the grid of your planned character into columns. The height and number of columns depend on the traits of the characters you are defining.

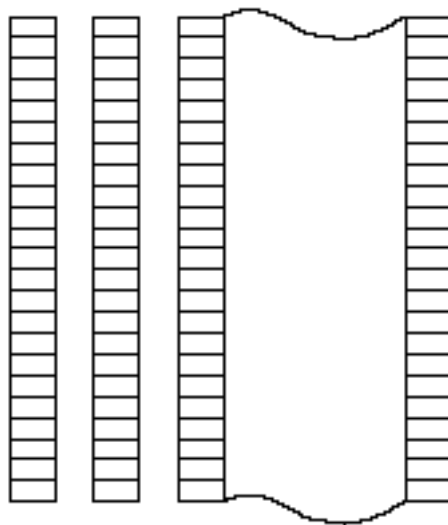

24-pin normal height

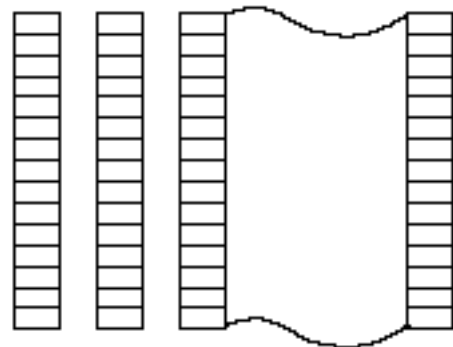

24-pin super/subscript

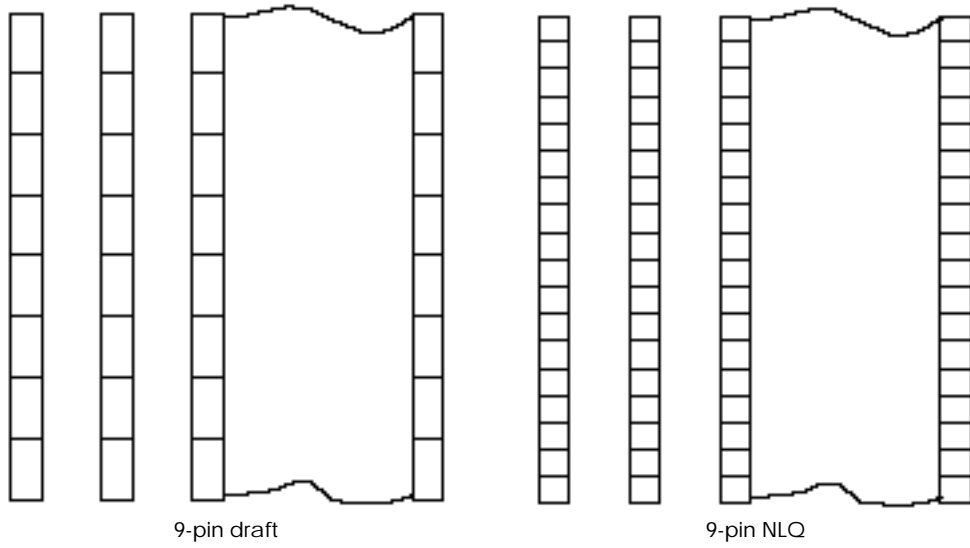

2. Divide each column into the following groups, depending on character and printer traits.

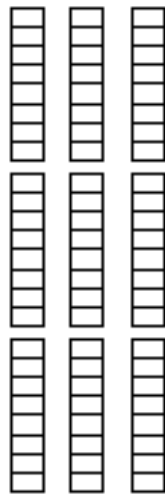

24-pin normal height  
3 groups of 8 dots

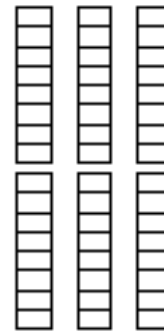

24-pin super/subscript  
2 groups of 12 dots

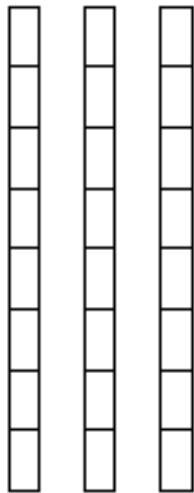

9-pin draft  
1 group of 8 dots

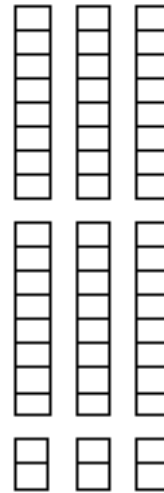

9-pin NLQ  
2 groups of 8 dots, 1 group of 2 dots

3. Each group of dots is represented by a byte of data, and each dot within that group has a value as shown below. Add up the value of each dot in the group; the result is the value for the byte of data.

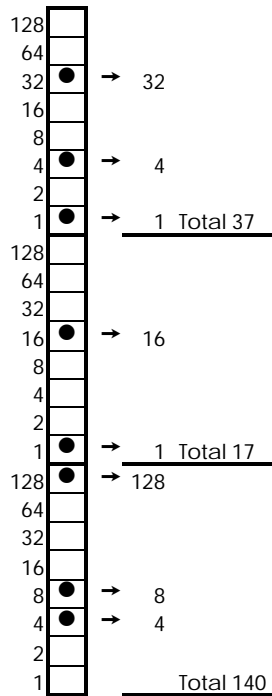

24-pin normal height  
(byte values are the same  
for super/subscript)

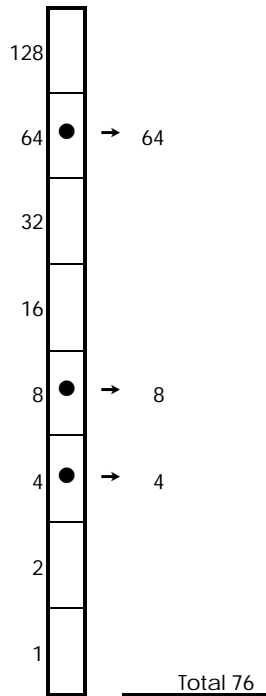

9-pin draft

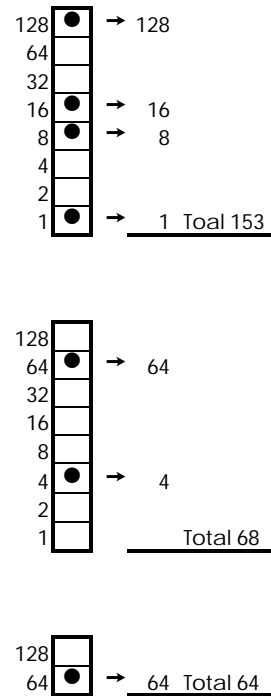

9-pin NLQ

4. Determine the value of the data bytes for all the columns in your design. The printer requires data in the order shown below.

1	4	7	
2	5	8	
3	6	9	

24-pin normal height

1	3	5	
2	4	6	

24-pin super/subscript

1	2	3	
---	---	---	--

9-pin draft

1	4	7	
2	5	8	
3	6	9	

9-pin NLQ

**Note:**

The printer must receive complete columns of data. In other words, the number of bytes received must be a multiple of 3 for normal-height characters (on 24/48-pin printers) and 9-pin NLQ characters, or a multiple of 2 for super/subscript characters. Draft 9-pin character columns are only 1-byte high.

## Deciding where to store data

On 24/48-pin printers, you can copy characters directly into RAM memory in character locations 0 to 127. You can also use the ESC t 2 command to copy the characters you have defined to locations 128 to 255; then you can print all characters, including those at locations normally treated as control codes. See “Switching to RAM character printing” for details.

0	10	20	30	40	50	60	70	80	90	A0	B0	C0	D0	E0	F0
0 NUL	SP	0	@	P	i	o	NUL	SP	0	@	P	i	o	p	
1 DC1	1	1	A	O	a	q	DC1	1	1	A	O	a	q	q	
2 DC2	2	2	B	R	b	r	DC2	2	2	B	R	b	r	r	
3 DC3	3	3	C	S	c	s	DC3	3	3	C	S	c	s	s	
4 DC4	4	4	D	T	d	t	DC4	4	4	D	T	d	t	t	
5 %	5	5	E	U	e	u	%	5	5	E	U	e	u	u	
6 &	6	6	F	V	f	v	&	6	6	F	V	f	v	v	
7 BEL	7	7	G	W	g	w	BEL	7	7	G	W	g	w	w	
8 BS CAN	8	8	H	X	h	x	BS CAN	8	8	H	X	h	x	x	
9 HT EM	9	9	J	Y	j	y	HT EM	9	9	I	Y	i	y	y	
A LF	A	A	J	Z	j	z	LF	A	A	J	Z	j	z	z	
B VT ESC	B	B	K	[	k	{	VT ESC	B	B	K	[	k	{	{	
C FF	C	C	L	\	l		FF	C	C	L	\	l			
D CR	D	D	M	]	m	}	CR	D	D	M	]	m	}	}	
E SO	E	E	N	^	n	~	SO	E	E	N	^	n	~	~	
F SI	F	F	O	_	o	DEL	SI	F	F	O	_	o	DEL	DEL	

On most 9-pin printers, you can copy directly to 241 of the 256 RAM memory locations (you can copy only 6 characters on LX printers, from locations 58 to 63). The following diagram illustrates the memory locations available.

	0	10	20	30	40	50	60	70	80	90	A0	B0	C0	D0	E0	F0
0	NUL	SP	0	@	P	!	q	NUL	SP	0	@	P	!	q		
1	DC1	"	1	A	O	a	q	DC1	"	1	A	O	a	q		
2	DC2	"	2	B	R	b	r	DC2	"	2	B	R	b	r		
3	DC3	#	3	C	S	c	s	DC3	#	3	C	S	c	s		
4	DC4	\$	4	D	T	d	t	DC4	\$	4	D	T	d	t		
5		%	5	E	U	e	u	%	5	E	U	e	u			
6		&	6	F	V	f	v	&	6	F	V	f	v			
7	BEL		7	G	W	g	w	BEL		7	G	W	g	w		
8	BS	CAN	(	8	H	X	h	x	BS	CAN	(	8	H	X	h	x
9	HT	EM	)	9	I	Y	i	y	HT	EM	)	9	I	Y	i	y
A	LF	*	*	J	Z	j	z	LF	*	*	J	Z	j	z		
B	VT	ESC	+	K	[	k	{	VT	ESC	+	K	[	k	{		
C	FF	<	<	L	\	l		FF	<	<	L	\	l			
D	CR	=	=	M	]	m	}	CR	=	=	M	]	m	}		
E	SO	>	>	N	^	n	~	SO	>	>	N	^	n	~		
F	SI	/	/	O	_	o	DEL	SI	/	/	O	_	o	DEL		

The printer normally treats some of these codes as control codes. To print characters you store in these locations, see "Switching to RAM character printing" later in this section.

## Sending user-defined characters to the printer

ESC/P 2

ESC/P

For 24/48-pin printers, use the ESC & command to send user-defined data to the printer. The format of the command is:

ESC & NUL n m [a<sub>0</sub> a<sub>1</sub> a<sub>2</sub> d<sub>0</sub> d<sub>1</sub> d<sub>2</sub> . . . d<sub>k</sub>]

The value for n is the location of the first consecutive character you wish to redefine; m is the last character. See the ASCII character table in the Appendix for the order of the characters. To define just one character, n is the same as m.

Parameter a<sub>0</sub> specifies the number of blank columns to the left of the character and a<sub>2</sub> the blank columns to the right. The value for a<sub>1</sub> specifies the width of the character you are defining in dot columns.

Repeat the data within the brackets for each character you are defining. You must send a<sub>0</sub>, a<sub>1</sub>, and a<sub>2</sub> for each character you define. After sending a<sub>0</sub>, a<sub>1</sub>, and a<sub>2</sub>, send the actual dot data for each character, as described in “Preparing data.”

The following example replaces the + character with the following user-defined character:

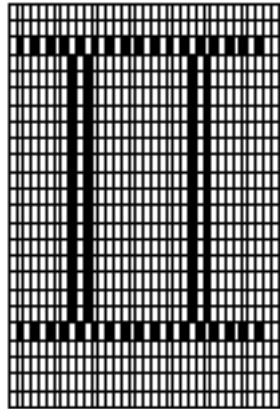

First set the traits. For this character, define a normal height, fixed-pitch, LQ-mode character. The following commands set the traits (see “Setting user-defined character traits”):

ESC x 1	Selects LQ mode
ESC p 0	Cancels proportional spacing
ESC T	Cancels super/subscript
ESC 5	Cancels italic printing

Next, send the data for the character.

The character code of the character being replaced (+) is 43. Set n and m to 43.

Since you will not add any space to the left or right of the character, set the  $a_0$  and  $a_2$  parameters to 0. Since the character width is 34 columns, set  $a_1$  equal to 34. Then send the dot data.

The resulting command is as follows:

```
ESC & 0 43 43 0 34 0
```

The data (102 bytes) is as follows

```
0, 0, 0, 32, 0, 16, 0, 0, 0, 32, 0, 16, 0, 0, 0, 32, 0, 16, 0, 0, 0, 32, 0, 16, 31, 255, 224,
32, 0, 16, 31, 255, 244, 32, 0, 16, 0, 0, 0, 32, 0, 16, 0, 0, 0, 32, 0, 16, 0, 0, 0, 32, 0, 16,
0, 0, 0, 32, 0, 16, 0, 0, 0, 32, 0, 16, 0, 0, 0, 32, 0, 16, 31, 255, 224, 32, 0, 16, 31, 255,
224, 32, 0, 16, 0, 0, 0, 32, 0, 16, 0, 0, 0, 32, 0, 16, 0, 0, 0, 32, 0, 16
```

The character is now stored in location 43, the former + location. You can print the character by switching to RAM printing (see “Switching to RAM character printing”) and then sending code 43 (the + character).

#### 9-Pin ESC/P

Use the ESC & command to send user-defined data to the printer. The format of the command is:

Draft characters:       ESC & NUL n m [a d<sub>0</sub> d<sub>1</sub> d<sub>2</sub> . . . d<sub>k</sub>]

NLQ-mode characters:ESC & NUL n m [0 a 0 d<sub>0</sub> d<sub>1</sub> d<sub>2</sub> . . . d<sub>k</sub>]

The value for  $n$  is the location of the first consecutive character you wish to redefine;  $m$  is the last character. See the ASCII character table in the Appendix for the order of the characters. To define just one character,  $n$  is the same as  $m$ .

Parameter  $a$  is called the attribute byte; the purpose of the attribute byte is different for draft and NLQ characters. Both explanations are included below.

#### *The attribute byte for draft 9-pin characters*

With draft 9-pin characters, the attribute byte sets the following parameters of the character you are defining:

- The pin group (the upper 8 pins or the lower 8 pins)
  - Select the upper 8 pins if your character has no descenders.
  - Select the lower 8 pins if your character has descenders.
- The beginning column (during proportional spacing)
  - The ending column (during proportional spacing)

This information is stored within the attribute byte as shown below.

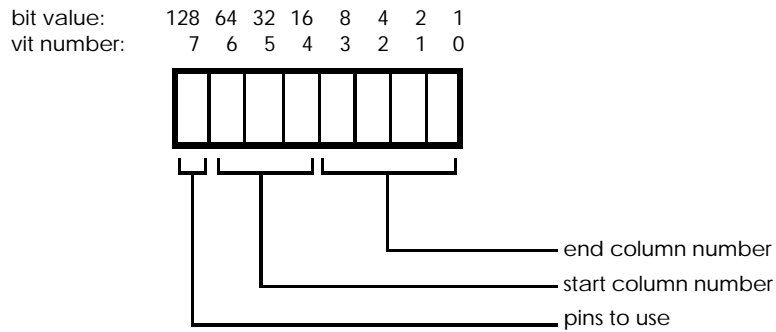

To determine the value of the attribute byte, add up the numbers for the parameters you wish to set.

*Attribute byte table*

Beginning Column		Ending Column		Upper/Lower 8 pins	
Column number	Value	Column number	Value	Pin group	Value
0	0	1	1	Upper 8 pins	128
1	16	2	2	Lower 8 pins	0
2	32	3	3		
3	48	4	4		
4	64	5	5		
5	80	6	6		
6	96	7	7		
7	112	8	8		
		9	9		
		10	10		
		11	11		

**Note:**

- The beginning column and ending column settings are only used during proportional spacing. During proportional spacing, the columns to the left of the beginning column and to the right of the ending column are cut off.
- Proportional spacing is not available on LX-series printers.

For example, to define a character that begins in column 2 and ends in 9 (during proportional spacing) and is printed with the upper 8 pins, determine the attribute byte as follows:

	Value	
Beginning column is 2	32	
Ending column is 9	9	
Upper 8 pins	<u>128</u>	
Total attribute byte	= 169	

You must send an attribute byte for each character you define.

### *The attribute byte for NLQ 9-pin characters*

With NLQ characters, the attribute byte determines the width of the character only.

Determine the width of your pattern data in columns (1 to 12) and set the attribute byte equal to the number of columns. Repeat the data within the brackets for each character you are defining. You must send an attribute byte for each character you define.

### *Examples*

The following example replaces the + character with the following 9-pin, draft, user-defined character:

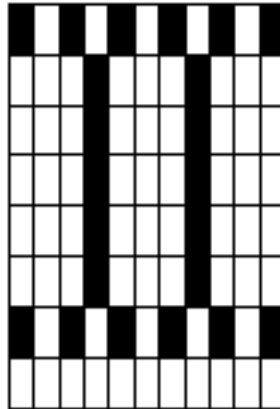

### **Note:**

Only the characters with codes between 58 and 63 may be user-defined on an LX-series printer.

First set the attributes. The following commands do this (see “Setting user-defined character traits”):

ESC x 0                      Selects draft mode

ESC 5                        Cancels italic printing

Next, send the data for the character. You must select the beginning and ending column if you want to use the character during proportional spacing; also, in this example you will be using the upper 8 pins.

To determine the value of the attribute byte, look at the chart above; your character starts in column 0 and ends in column 10.

	Value	
Beginning column is 0	0	
Ending column is 10	10	
Upper 8 pins	<u>128</u>	
Total attribute byte	=	138

Following the attribute byte is the pattern data.

The resulting command is as follows:

```
ESC & 0 43 43 169
```

The data (11 bytes) is as follows:

```
130, 0, 130, 124, 130, 0, 130, 124, 130, 0, 130
```

The command is now stored in location 43, the former + location. You can print the character by switching to RAM printing (see the following section) and then sending code 43 (the + character).

The following example replaces the = character with the following 9-pin NLQ user-defined character:

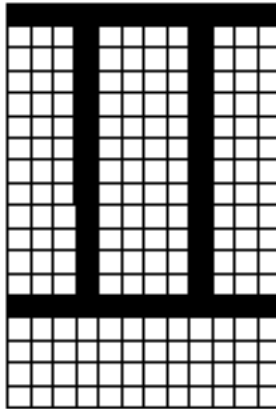

First set the attributes. The following commands do this (see “Setting user-defined character traits”):

```
ESC x 1           Selects NLQ mode
```

```
ESC 5            Cancels italic printing
```

Next, send the data for the character. Since this is an NLQ character, you must set the attribute byte to equal the character width. In this case, the width is 12 columns.

Send the pattern data following the attribute byte. The resulting command is as follows:

```
ESC & 0 61 61 0 12 0
```

The data (36 bytes) is as follows:

```
128, 8, 0, 128, 8, 0, 128, 8, 0, 255, 248, 0, 128, 8, 0, 128, 8, 0, 128, 8, 0, 128, 8, 0, 255, 248, 0, 128, 8, 0, 128, 8, 0, 128, 8, 0
```

The command is now stored in location 61, the former = location. You can print the character by switching to RAM printing (see the following section) and then sending code 61 (the = character).

## Switching to RAM character printing

ESC/P 2

ESC/P

9-Pin ESC/P

Once you store user-defined characters in the printer (using the ESC & command), use the ESC % command to tell the printer to switch to RAM character printing. The format of the command is as follows:

ESC % 0                      Selects ROM characters

ESC % 1                      Selects user-defined characters (RAM memory)

After sending the ESC % 1 command, you can print the characters in the memory locations outlined below:

24/48-pin printer

	0	10	20	30	40	50	60	70	80	90	A0	B0	C0	D0	E0	F0
0	NUL	SP	0	@	P	!	q	NUL	SP	0	@	P	!	q		
1	DC1	1	A	O	a	q	DC1	!	i	A	Q	a	q			
2	DC2	2	B	R	b	r	DC2	"	2	B	R	b	r			
3	DC3	#	3	C	S	c	s	DC3	#	3	C	S	c	s		
4	DC4	\$	4	D	T	d	t	DC4	\$	4	D	T	d	t		
5	%	5	E	U	e	u	%	5	E	U	e	u				
6	&	6	F	V	f	v	&	6	F	V	f	v				
7	BEL	7	G	W	g	w	BEL	7	G	W	g	w				
8	BS CAN	(	8	H	X	h	x	BS CAN	(	8	H	X	h	x		
9	HT EM	)	9	I	Y	i	y	HT EM	)	9	I	Y	i	y		
A	LF	*	A	J	Z	j	z	LF	*	A	J	Z	j	z		
B	VI ESC	+	B	K	[	k	{	VI ESC	+	B	K	[	k	{		
C	FF	<	C	L	\	l		FF	<	C	L	\	l			
D	CR	-	D	M	]	m	}	CR	-	D	M	]	m	}		
E	SO	>	E	N	^	n	~	SO	>	E	N	^	n	~		
F	SI	/	F	O	_	o	DEL	SI	/	F	O	_	o	DEL		

9-pin printer

	0	10	20	30	40	50	60	70	80	90	A0	B0	C0	D0	E0	F0
0	NUL 0	SP 16	0 32	0 48	@ 84	P 96	i 108	o 112	NUL 128	SP 144	0 160	@ 176	P 192	i 208	o 224	p 240
1	DC1 1	1 17	1 33	A 49	O 85	a 97	q 113	DC1 129	1 145	1 161	A 177	O 193	a 209	q 225	A 241	
2	DC2 2	2 18	2 34	B 50	R 86	b 98	r 114	DC2 130	2 146	2 162	B 178	R 194	b 210	r 226	B 242	
3	DC3 3	3 19	3 35	C 51	S 87	c 99	s 115	DC3 131	3 147	3 163	C 179	S 195	c 211	s 227	C 243	
4	DC4 4	4 20	4 36	D 52	T 88	d 100	t 116	DC4 132	4 148	4 164	D 180	T 196	d 212	t 228	D 244	
5	5 21	5 21	5 37	E 53	U 89	e 101	u 117	5 133	5 149	5 165	E 181	U 197	e 213	u 229	E 245	
6	6 22	6 22	6 38	F 54	V 90	f 102	v 118	6 134	6 150	6 166	F 182	V 198	f 214	v 230	F 246	
7	BEL 7	7 23	7 39	G 55	W 91	g 103	w 119	BEL 135	7 151	7 167	G 183	W 199	g 215	w 231	G 247	
8	BS 8	CAN 24	8 40	H 56	X 92	h 104	x 120	BS 136	CAN 152	8 168	H 184	X 200	h 216	x 232	H 248	
9	HT 9	EM 25	9 41	I 57	Y 93	i 105	y 121	HT 137	EM 153	9 169	I 185	Y 201	i 217	y 233	I 249	
A	LF 10	26	10 42	J 58	Z 94	j 106	z 122	LF 138	104	10 170	J 186	Z 202	j 218	z 234	J 250	
B	VT 11	ESC 27	11 43	K 59	[ 95	k 107	{ 123	VT 139	ESC 154	11 171	K 187	[ 203	k 219	{ 235	K 251	
C	FF 12	28	12 44	L 60	\ 96	l 108	 124	FF 140	155	12 172	L 188	\ 204	l 220	 236	L 252	
D	CR 13	29	13 45	M 61	] 97	m 109	} 125	CR 141	156	13 173	M 189	] 205	m 221	} 237	M 253	
E	SO 14	30	14 46	N 62	> 98	n 110	~ 126	SO 142	157	14 174	N 190	> 206	n 222	~ 238	N 254	
F	SI 15	31	15 47	O 63	? 99	o 111	DEL 127	SI 143	158	15 175	O 191	? 207	o 223	DEL 239	O 255	

The method of accessing characters in other areas varies depending on the type of printer.

There are two ways to access user-defined characters 0 to 31.

**ESC/P 2**

The first method is available only on ESC/P 2 printers. After changing to RAM characters with the ESC % 1 command, use the ESC ( ^ command to send character data. All data sent with the ESC ( ^ command is treated as character data. See ESC ( ^ in the Command Summary for details.

The table of accessible characters is as follows:

	0	10	20	30	40	50	60	70	80	90	A0	B0	C0	D0	E0	F0
0	NUL	SP	0	@	P	!	0	NUL	SP	0	@	P	!	0	P	p
1	DC1	"	1	A	Q	a	q	DC1	"	1	A	Q	a	q	Q	q
2	DC2	"	2	B	R	b	r	DC2	"	2	B	R	b	r	R	r
3	DC3	#	3	C	S	c	s	DC3	#	3	C	S	c	s	S	s
4	DC4	\$	4	D	T	d	t	DC4	\$	4	D	T	d	t	T	t
5	%	%	5	E	U	e	u	%	%	5	E	U	e	u	E	u
6	&	&	6	F	V	f	v	&	&	6	F	V	f	v	V	v
7	BEL		7	G	W	g	w	BEL		7	G	W	g	w	W	w
8	BS	CAN	(	8	H	X	h	x	BS	CAN	(	8	H	X	h	x
9	HT	EM	)	9	J	Y	j	y	HT	EM	)	9	J	Y	j	y
A	LF	*	*	A	J	Z	j	z	LF	*	*	A	J	Z	j	z
B	VT	ESC	+	B	K	[	k	{	VT	ESC	+	B	K	[	k	{
C	FF	<	<	C	L	\	l		FF	<	<	C	L	\	l	
D	CR	=	=	D	M	]	m	}	CR	=	=	D	M	]	m	}
E	SO	>	>	E	N	^	n	~	SO	>	>	E	N	^	n	~
F	SI	/	?	F	O	_	o	DEL	SI	/	?	F	O	_	o	DEL

The second method is to select ESC % 0 (ROM character printing) and then send the ESC t 2 command. ESC t 2 copies all user-defined characters to the upper half of the character memory, and leaves the lower half as ROM characters. (In other words, the ESC t 2 command adds 128 to the user-defined character codes.)

	0	10	20	30	40	50	60	70	80	90	A0	B0	C0	D0	E0	F0
0	NUL		SP	0	@	P	t	p	NUL		SP	0	@	P	t	p
1	DC1		"	1	A	Q	a	q	DC1		"	1	A	Q	a	q
2	DC2		"	2	B	R	b	r	DC2		"	2	B	R	b	r
3	DC3		#	3	C	S	c	s	DC3		#	3	C	S	c	s
4	DC4		\$	4	D	T	d	t	DC4		\$	4	D	T	d	t
5			%	5	E	U	e	u			%	5	E	U	e	u
6			&	6	F	V	f	v			&	6	F	V	f	v
7	REL		'	7	G	W	g	w	REL		'	7	G	W	g	w
8	BS	CAN	(	8	H	X	h	x	BS	CAN	(	8	H	X	h	x
9	HT	EM	)	9	I	Y	i	y	HT	EM	)	9	I	Y	i	y
A	LF		*	:	J	Z	j	z	LF		*	:	J	Z	j	z
B	VT	ESC	+	;	K	[	k	{	VT	ESC	+	;	K	[	k	{
C	FF		<		L	\	l		FF		<		L	\	l	
D	CR		=		M	]	m	}	CR		=		M	]	m	}
E	SO		>		N	^	n	~	SO		>		N	^	n	~
F	SI		?		O	_	o	DEL	SI		?		O	_	o	DEL

The codes between 128 and 159, as well as between 0 and 31, are usually treated as control codes. Send the ESC I and ESC 6 commands to access characters 128 to 159 and the 18 non-control codes between 0 and 31.

The table of accessible characters then appears as below:

	0	10	20	30	40	50	60	70	80	90	A0	B0	C0	D0	E0	F0
0	NUL		SP	0	@	P	!	p	NUL		SP	0	@	P	!	p
1	DC1	1	1	A	O	a	q	DC1	1	1	A	O	a	q	DC1	1
2	DC2	2	2	B	R	b	r	DC2	2	2	B	R	b	r	DC2	2
3	DC3	#	3	C	S	c	s	DC3	#	3	C	S	c	s	DC3	#
4	DC4	\$	4	D	T	d	t	DC4	\$	4	D	T	d	t	DC4	\$
5		%	5	E	U	e	u		%	5	E	U	e	u		%
6		&	6	F	V	f	v		&	6	F	V	f	v		&
7	REL		7	G	W	g	w	REL		7	G	W	g	w	REL	
8	BS CAN	(	8	H	X	h	x	BS CAN	(	8	H	X	h	x	BS CAN	(
9	HT EM	)	9	I	Y	i	y	HT EM	)	9	I	Y	i	y	HT EM	)
A	LF	*		J	Z	j	z	LF	*		J	Z	j	z	LF	*
B	VT ESC	+		K	[	k	{	VT ESC	+		K	[	k	{	VT ESC	+
C	FF	<		L	\	l		FF	<		L	\	l		FF	<
D	CR	=		M	]	m	}	CR	=		M	]	m	}	CR	=
E	SO	>		N	^	n	~	SO	>		N	^	n	~	SO	>
F	SI	?		O	_	o	DEL	SI	?		O	_	o	DEL	SI	?

## Selecting an international character set

ESC/P 2

ESC/P

9-Pin ESC/P

You can change up to 12 of the characters in the current character table with the ESC R command. These 12 characters are called international character sets because they correspond to characters commonly used in several foreign languages.

The format for this command is as follows:

ESC R n

The parameter n determines which character set is selected.

The table below shows these characters and their codes in the Helvetica typeface, as well as the value of the parameter used in the ESC R command to select each character set.

n	Set name	Dec Hex	35 23	36 24	64 40	91 5B	92 5C	93 5D	94 5E	96 60	123 7B	124 7C	125 7D	126 7E
0	USA	#	\$	@	[	\	]	^	`	{		}	~	
1	France	#	\$	à	°	ç	§	^	`	é	ù	è	¨	
2	Germany	#	\$	§	Ä	Ö	Ü	^	`	ä	ö	ü	ß	
3	UK	£	\$	@	[	\	]	^	`	{		}	~	
4	Denmark I	#	\$	@	Æ	Ø	Å	^	`	æ	ø	å	~	
5	Sweden	#	¤	É	Ä	Ö	Å	Ü	é	ä	ö	å	ü	
6	Italy	#	\$	@	°	\	é	^	ù	à	ò	è	ì	
7	Spain I	Pt	\$	@	ı	Ñ	ı	^	`	¨	ñ	}	~	
8	Japan (Eng)	#	\$	@	[	¥	]	^	`	{		}	~	
9	Norway	#	¤	É	Æ	Ø	Å	Ü	é	æ	ø	å	ü	
10	Denmark II	#	\$	É	Æ	Ø	Å	Ü	é	æ	ø	å	ü	
11	Spain II	#	\$	á	ı	Ñ	ı	é	`	í	ñ	ó	ú	
12	Lat America	#	\$	á	ı	Ñ	ı	é	ü	í	ñ	ó	ú	
13	Korea	#	\$	@	[	₩	]	^	`	{		}	~	
64	Legal	#	\$	§	°	'	"	¶	`	©	®	†	™	

## Select a Font

ESC/P 2

ESC/P

9-Pin ESC/P

ESC/P 2 includes the ESC X command for selecting scalable fonts; differences in handling scalable fonts are discussed in each section.

The term font is often confused with typeface. Because the electronic printer field has evolved from basic beginnings, these two terms have often been used interchangeably.

However, fonts are defined by six attributes:

Attributes	ESC/P 2	Previous ESC/P levels
Character table	ESC t, ESC ( t	ESC t
Point size (height)	ESC X	ESC w
Typeface	ESC k	ESC k
Pitch (proportional/fixed spacing)	ESC X, ESC c	ESC P, M, g, p, W, ESC SP, SO, SI, DC2, DC4
Style (italics/normal)	ESC 4, ESC 5	ESC 4, ESC 5
Weight (bold/normal)	ESC E, ESC F	ESC E, ESC F

Each time you change one of the above attributes, the printer selects a new font. If a font matching the selected attributes is not available in the printer's ROM memory, the printer manufactures a temporary font with those attributes.

You can set these attributes in any order; changing one attribute does not affect any other attribute. However, the printer selects fonts internally in the above order, so using that order is the most efficient.

You can modify each font with several enhancements, as follows:

Double-strike           ESC G, ESC H

Score                    ESC ( -, ESC -

Shadow/outline        ESC q

## Print quality (draft, LQ, or NLQ)

ESC/P 2

ESC/P

9-Pin ESC/P

The following attributes are limited during draft printing:

- Typeface Draft typeface only
- Point size 10.5 and 21-point sizes only

Use the ESC x command to select the print quality, according to the following format:

ESC x 0	Selects draft print quality
ESC x 1	Selects LQ print quality for ESC/P 2 and ESC/P Selects NLQ print quality for 9-Pin ESC/P

## Standard and scalable fonts (multipoint mode)

ESC/P 2

ESC/P

9-Pin ESC/P

Both ESC/P 2 and previous ESC/P level printers can print the standard 10.5-point fonts. You can modify the point size (height) and pitch of these characters with the following commands:

<i>Size</i>	
SO, ESC W	Double-width printing
ESC w	Double-height printing
SI	Condensed printing
 <i>Spacing</i>	
ESC P	Select 10 cpi
ESC M	Select 12 cpi
ESC g	Select 15 cpi (24/48-pin printers only)
ESC p	Select proportional spacing
ESC SP	Add additional space between characters

By using ESC/P 2's ESC X command to enter multipoint mode, you can select scalable fonts. Scalable fonts allow you to directly specify the point size and pitch of your characters.

Not all typefaces are available in multipoint mode; see the Command Table for the typefaces available in multipoint mode on each printer.

During multipoint mode, sending the commands below results in the following:

Commands ignored		Commands that cancel multipoint mode	
ESC W	Double-width	ESC P	Select 10 cpi
ESC w	Double-height	ESC M	Select 12 cpi
ESC SP	Additional space	ESC g	Select 15 cpi
SI	Condensed printing	ESC p	Select proportional
SO	Double-width	ESC !	Master select
DC2	Cancel condensed	ESC @	Reset
DC4	Cancel double-width		
ESC k	(if typeface is not available in multipoint mode)		

### Selecting the character table

Use the ESC t command to select the character table. The format for this command is as follows:

ESC t n

The parameter n is the number of the character table.

ESC/P 2

With ESC/P 2, you can select from four active character tables. See “Assign character tables” for details.

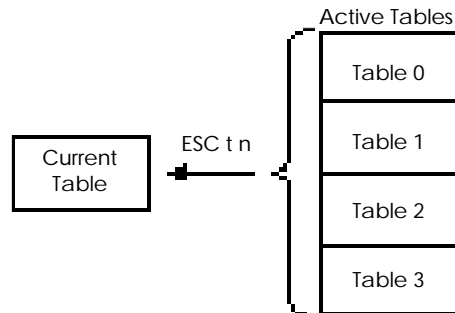

ESC/P

9-Pin ESC/P

With previous ESC/P versions, you can select from two character tables: italics and graphics.

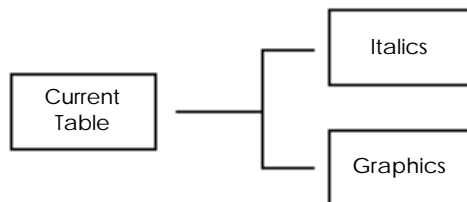

The character table is one attribute of the font. Selecting a different character table selects a different font.

## Selecting the point size

The height of characters is measured in points. One point is equal to 1/72 inch.

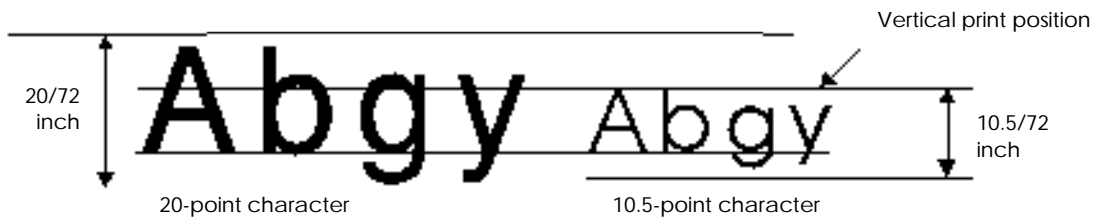

ESC/P 2

If you plan to use typefaces available in multipoint mode, you can set the point size with the ESC X command. This command puts the printer in multipoint mode and sets the point and pitch of the font.

The format of the ESC X command is as follows:

ESC X m n<sub>L</sub> n<sub>H</sub>

The m parameter sets the pitch and the n<sub>L</sub> and n<sub>H</sub> parameters set the point size, according to the following formulas:

Pitch      m = 0    the pitch does not change; use this value if you plan to change only the point size.

                  1    proportional spacing is selected.

                  m ≥ 5     $\frac{360}{m}$  cpi character spacing

Point size

$$(\text{point size}) = \frac{(n_H \times 256) + n_L}{2}$$

If n<sub>H</sub> and n<sub>L</sub> both equal 0, the point size does not change; use these values if you plan to change only the pitch.

ABCDefgh12345!@#\$\$%^

32 points

ABCDefgh12345!@#\$\$%^

26 points

ABCDefgh12345!@#\$\$%^

20 points

ABCDefgh12345!@#\$\$%^

14 points

ABCDefgh12345!@#\$\$%^

8 points

ABCDefgh12345!@#\$\$%^

30 points

ABCDefgh12345!@#\$\$%^

24 points

ABCDefgh12345!@#\$\$%^

18 points

ABCDefgh12345!@#\$\$%^

12 points

**Note:**

- Some commands are ignored during multipoint mode and some commands cancel multipoint mode. See the list in “Standard and scalable fonts (multipoint mode).”
- You can select characters equivalent to previous ESC/P levels by adjusting the point and pitch with the ESC X command. See the Appendix for details.
- The baseline of all characters is 20/180 inch below the current vertical print position. See “Selecting the print position.”

Non-ESC/P 2 and typefaces not available in multipoint mode

Characters normally have a size of 10.5 points. You can also print 21-point characters as shown below.

ESC w 1                      Selects double-height (21-point) characters

ESC w 0                      Selects normal (10.5-point) characters

### Selecting the typeface

Select the typeface using the ESC k command. The parameters for selecting each available typeface setting are shown below:

Command	Typeface name	Character samples (24-pin)
ESC k 0	Roman	abcdefghijklmnopqrstuvwxyz
ESC k 1	Sans serif	abcdefghijklmnopqrstuvwxyz
*ESC k 2	Courier	abcdefghijklmnopqrstuvwxyz
*ESC k 3	Prestige	abcdefghijklmnopqrstuvwxyz
*ESC k 4	Script	<i>abcdefghijklmnopqrstuvwxyz</i>
*ESC k 5	OCR-B	abcdefghijklmnopqrstuvwxyz
*ESC k 6	OCR-A	abcdefghijklmnopqrstuvwxyz
*ESC k 7	Orator	ABCDEFGHIJKLMNopqrstuvwxyz
*ESC k 8	Orator-S	abcdefghijklmnopqrstuvwxyz
*ESC k 9	Script C	<i>abcdefghijklmnopqrstuvwxyz</i>

\*Only available on 24/48-pin printers

#### **Note:**

Not all typefaces are available in multipoint mode; see the Feature Summary for the typefaces available in multipoint mode.

## Selecting the pitch

### ESC/P 2

ESC/P 2 provides two ways of setting the pitch: the ESC X command and the ESC c command.

If you plan to use multipoint mode typefaces, you can set the pitch with the ESC X command. This command puts the printer in multipoint mode and sets the pitch and point size of the font.

The format of the ESC X command is as follows:

ESC X m n<sub>L</sub> n<sub>H</sub>

The m parameter sets the pitch and the n<sub>L</sub> and n<sub>H</sub> parameters set the point size, according to the following formulas:

Pitch      m = 0    The pitch does not change

                  1    Proportional spacing is selected

                  m ≥ 5     $\frac{360}{m}$  cpi character spacing

Point size

$$(\text{point size}) = \frac{(n_H \times 256) + n_L}{2}$$

If n<sub>H</sub> and n<sub>L</sub> both equal 0, the point size does not change; use this value if you plan to change only the pitch.

See the section on proportional character width during multipoint mode in the Appendix.

**Note:**

- Some commands are ignored during multipoint mode and some commands cancel multipoint mode. See the list in “Standard and scalable fonts (multipoint mode).”
- You can select characters equivalent to previous ESC/P levels by adjusting the point and pitch with the ESC X command. See the Appendix for details.

You can also set the pitch with the ESC c command. This command sets the horizontal motion index (HMI) in inches per character rather than in cpi. The format of this command is as follows:

ESC c n<sub>L</sub> n<sub>H</sub>

$$\text{HMI} = \frac{(n_H \times 256) + n_L}{360} \text{ inch}$$

$$n_H = \text{INT} \frac{\text{HMI} \times 360}{256}$$

$$n_L = \text{MOD} \frac{\text{HMI} \times 360}{256}$$

The HMI set with the ESC c command cancels the pitch set with the ESC X command.

The following commands cancel the HMI set with the ESC c command:

ESC W	Double-width	ESC P	Select 10 cpi
ESC M	Select 12 cpi	ESC w	Double-height
ESC SP	Additional space	ESC g	Select 15 cpi
SI	Condensed printing	ESC p	Select proportional
SO	Double-width	ESC !	Master select
DC2	Cancel condensed	ESC @	Reset
DC4	Cancel double-width	ESC X	Select pitch and point

ESC/P 2

ESC/P

9-Pin ESC/P

*Non-ESC/P 2 printers and typefaces not available in multipoint mode*

For previous ESC/P-level printers, as well as ESC/P 2 printers that are not in multipoint mode, you can adjust the character pitch by setting the following features:

Proportional spacing	10-cpi character spacing
12-cpi character spacing	15-cpi character spacing
Condensed printing	Intercharacter spacing
Double-width printing	

The following commands produce the fixed pitches indicated:

Pitch	Individual commands	Master Select
5 cpi	ESC W 1, ESC P	ESC ! 32
6 cpi	ESC W 1, ESC M	ESC ! 33
7.5 cpi*	ESC W 1, ESC g	ESC ! 32, ESC g
10 cpi	ESC P	ESC ! 0
12 cpi	ESC M	ESC ! 1
15 cpi*	ESC g	N/A
17 cpi	ESC P, SI	ESC ! 4
20 cpi	ESC M, SI	ESC ! 5

\*These pitches are not available on 9-pin printers.

**Note:**

- When you select the 7.5-cpi and 15-cpi pitches the character height is reduced on most printers.
- See ESC ! (the Master Select command) in the Command Summary.

Use the ESC p command to select proportional spacing. In this type of spacing, the character width varies by character; thin characters like t receive less space than wide characters like M. The format for this command is as follows:

Individual command	Master select	
ESC p 1	ESC ! 2	Selects proportional spacing
ESC p 0	N/A	Cancel proportional spacing

See the proportional width table in the Appendix for the exact width of proportional width characters.

A final way you can adjust the pitch is with the ESC SP command. Use this command to add a fixed amount of space to the right of every character. The format of this command is as follows:

ESC SP n

The additional space is either n/120 inch or n/180 inch, depending on the current printer settings; see ESC SP in the Command Summary for details. This additional space is added to both fixed-pitch and proportional characters.

### Selecting the style



The term style refers to whether a character is upright or italic. Select the style attribute with the ESC 4 or ESC 5 commands.

ESC 4                      Select italic printing  
ESC 5                      Cancel italic printing (Select upright printing)

ABCDEFGHIJKLMnopqrstuvwxyZ  
Upright

*ABCDEFGHIJKLMnopqrstuvwxyZ*  
Italic

**Note:**

You cannot italicize graphics characters.

## Selecting the weight



The term weight refers to the thickness (or boldness) of printed lines in a character. Set the weight attribute with the ESC E and ESC F commands.

ESC E	Sets the weight attribute to bold
ESC F	Sets the weight attribute to normal (cancels bold)

**ABCDEFGHIJKLMnopqrstuvwxyz**

Normal

**ABCDEFGHIJKLMnopqrstuvwxyz**

Bold

## Enhancements

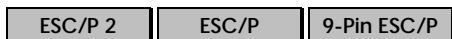

To modify fonts, several enhancements are available: double-strike, shadow, outline, and scoring.

On 9-pin printers, the only enhancement available is double-strike (only during draft printing) and single, continuous, and underline scoring.

These are not attributes of a font and do not affect font definition. These enhancements can be applied to both multipoint and normal fonts.

## Double-strike



The double-strike feature produces bolder printing by striking each dot twice. The commands for this feature are as follows:

ESC G	Selects double-strike printing
ESC H	Cancels double-strike printing

### **Note:**

On 9-pin printers, NLQ-mode overrides double-strike; double-strike resumes when the printer returns to draft printing.

**ABCDEFGHIJKLMnopqrstuvwxyz**

Normal

**ABCDEFGHIJKLMnopqrstuvwxyz**

Double-strike

## Shadow/outline

ESC/P 2

ESC/P

The shadow and outline enhancements are available only on 24/48-pin printers.

ABCDEFGHIJKLMnopqrstuvwxy<sup>z</sup>

Normal

ABCDEFGHIJKLMnopqrstuvwxy<sup>z</sup>

Outline

ABCDEFGHIJKLMnopqrstuvwxy<sup>z</sup>

Shadow

ABCDEFGHIJKLMnopqrstuvwxy<sup>z</sup>

Outline and shadow

The command for shadow/outline printing is ESC q; the format is as follows:

ESC q 0	Turn off outline/shadow printing
ESC q 1	Turn on outline printing
ESC q 2	Turn on shadow printing
ESC q 3	Turn on both outline and shadow printing

### **Note:**

This command does not affect graphics characters.

## Score

ESC/P 2

ESC/P

9-Pin ESC/P

Several types of scoring are available on 24/48-pin printers, as shown below:

ABCDEFGHIjklmno

ABCDEFGHIjklmno

ABCDEFGHIjklmno

ABCDEFGHIjklmno

ABCDEFGHIjklmno

ABCDEFGHIjklmno

ABCDEFGHIjklmno

ABCDEFGHIjklmno

ABCDEFGHIjklmno

ABCDEFGHIjklmno

ABCDEFGHIjklmno

ABCDEFGHIjklmno

### Note:

You can use the ESC- command to select single, continuous underlining on 9-pin printers. This is the only type of scoring available on 9-pin printers.

The command for selecting scoring is ESC ( -, and its format and combinations are as follows:

ESC ( - 3 0 1 n<sub>1</sub> n<sub>2</sub>

n<sub>1</sub> = 1 Underline  
2 Strikethrough  
3 Overscore

n<sub>2</sub> = 0 Turn off scoring  
1 Single continuous line  
2 Double continuous line  
5 Single broken line  
6 Double broken line

### Note:

- Each type of scoring is independent of other types; any combination of scoring can be set simultaneously.
- The score is printed in the currently selected print quality and is affected by the bold and double-strike commands.
- You cannot score graphics characters.

## Super/subscript

ESC/P 2

ESC/P

9-Pin ESC/P

The super/subscript command prints characters at approximately two-thirds the currently selected point size.

Superscript characters are printed in the upper two-thirds of the normal character space; subscript characters are printed in the lower two-thirds.

Super/subscript is available in both normal and multipoint modes.

Following are examples of super/subscript characters.

B<sup>D</sup> B<sub>D</sub>    b<sup>d</sup> b<sub>d</sub>

B<sup>D</sup> B<sub>D</sub>    b<sup>d</sup> b<sub>d</sub>

B<sup>D</sup> B<sub>D</sub>    b<sup>d</sup> b<sub>d</sub>

The commands for super/subscript printing and their format is as follows:

ESC S 1	Selects subscript printing
ESC S 0	Selects superscript printing
ESC T	Cancels super/subscript printing

### **Note:**

- You cannot print graphics characters as super/subscript characters.
- See “Proportional character widths” in the Appendix for information on the proportional width of super/subscript characters.
- During underline printing, the underline strikes through the descenders on subscript characters.
- During multipoint mode, the available point size nearest to two-thirds the size of the current font is selected for super/subscript characters.
- If the current point size is 8 points, super/subscript character size is not reduced.

## Select Supporting Features

Other features that affect the appearance of characters and graphics are unidirectional and color printing.

### Selecting unidirectional print head movement

ESC/P 2

ESC/P

9-Pin ESC/P

Normally, printing is bidirectional. Although the print head positions dots very accurately, print head movement has a slight effect on dot position. This effect is sometimes noticeable when printing graphics that include continuous vertical lines or large point-size characters.

To achieve maximum alignment accuracy, use the unidirectional feature. During unidirectional printing, the print head prints only from left to right.

Select unidirectional printing as follows:

ESC U 0	Selects bidirectional printing (cancels unidirectional)
ESC U 1	Selects unidirectional printing

### Selecting print color

ESC/P 2

ESC/P

9-Pin ESC/P

Use the ESC r command to select the print color on printers capable of color printing.

The format of the ESC r command is as follows:

ESC r 0	Black
ESC r 1	Magenta
ESC r 2	Cyan
ESC r 3	Violet
ESC r 4	Yellow
ESC r 5	Red
ESC r 6	Green

**Note:**

- Printers not capable of color printing ignore this command.
- Other colors are possible by overprinting the above colors. When combining yellow with other colors, always print yellow dots first (this prevents soiling of the print side of the ribbon).
- ESC/P 2 printers can print only black, magenta, cyan, and yellow during graphics mode.
- When printing in extended graphics mode selected with the ESC . 2 command, use the binary mode command <COLR> to select the color. Extended graphics mode is only available on the Stylus COLOR and later high-resolution printer models. For more information, see “Extended ESC/P 2 Programming Guide” later in this section.

### Select the Print Position



The definition of the vertical print position differs for text and graphics printing.

Physically, the print position corresponds to the top pin in the print head when graphics or 10.5-point characters are printed. However, to assure that the baseline of all characters is the same, the baseline is defined as 20/180 inch (7/72 inch for 9-pin printers) below the vertical print position no matter what point-size characters you are printing.

**Text printing**                      The baseline of the character is printed 20/180 inch (7/72 inch for 9-pin printers) below the vertical print position; the left-most column of the characters is printed at the horizontal position.

**Graphics printing**                The print position is the top printable row of dots.

The following diagram illustrates the relationship between the print head and the text/graphics print position.

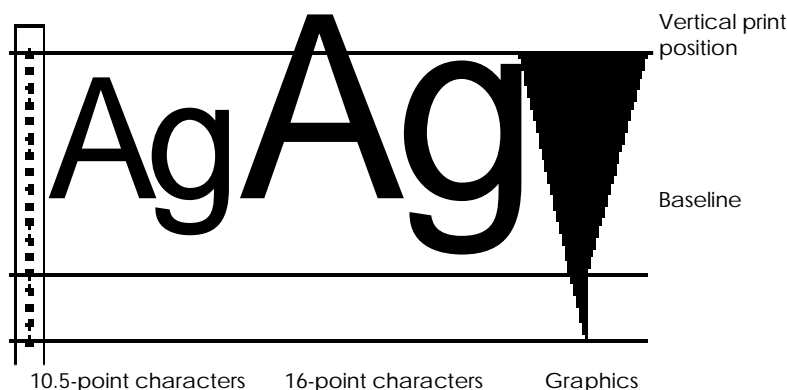

ESC/P 2 has new commands that allow for easier vertical and horizontal movement of the print position.

These new commands are:

ESC ( U	Sets a unit that is used for moving the print position and setting the page format
ESC ( V	Sets the absolute vertical position on the page
ESC ( v	Sets the relative vertical position on the page

Horizontal movement is performed with commands available in previous ESC/P versions. However, now the increment of movement is the unit set with the ESC ( U command.

ESC \$	Sets the absolute horizontal position
ESC \	Sets the relative horizontal position

The following sections describe moving the print position, with explanations for both ESC/P 2 and previous ESC/P versions.

### *Moving the horizontal position*

The horizontal print position is defined as the position where the left-most printable column of dots is printed for the next character or graphics design.

When you print characters or spaces, the printer automatically moves the print position according to the pitch you select (or the width of each character if you select proportional spacing).

To move the the horizontal print position independent of character printing, the recommended commands are as follows:

ESC \$	Set the absolute horizontal position
ESC \	Set the relative horizontal position
HT	Horizontal tab

The format of the ESC \$ command is as follows:

ESC \$ n<sub>L</sub> n<sub>H</sub>

The resulting horizontal position is determined by the formula below.

(horizontal position) = ((n<sub>H</sub> × 256) + n<sub>L</sub>) × (defined unit) + (left margin)

$$n_H = \text{INT} \left( \frac{((\text{horizontal position}) - (\text{left-margin position})) \times \frac{1}{(\text{defined unit})}}{256} \right)$$

$$n_L = \text{MOD} \left( \frac{((\text{horizontal position}) - (\text{left-margin position})) \times \frac{1}{(\text{defined unit})}}{256} \right)$$

The defined unit varies as follows:

ESC/P 2 printers      The unit defined with the ESC ( U command  
 Non-ESC/P 2 printers    1/60 inch

The format of the ESC \ command is as follows:

ESC \ n<sub>L</sub> n<sub>H</sub>

The horizontal position is determined by the formula below.

$$(\text{horizontal position}) = ((n_H \times 256) + n_L) \times (\text{defined unit}) + (\text{current position})$$

To move to the right of the current print position

$$n_H = \text{INT} \left( \frac{((\text{horizontal position}) - (\text{current position})) \times \frac{1}{(\text{defined unit})}}{256} \right)$$

$$n_L = \text{MOD} \left( \frac{((\text{horizontal position}) - (\text{current position})) \times \frac{1}{(\text{defined unit})}}{256} \right)$$

To move to the left of the current print position

$$n_H = 32768 - \text{INT} \left( \frac{((\text{current position}) - (\text{horizontal position})) \times \frac{1}{(\text{defined unit})}}{256} \right)$$

$$n_L = 32768 - \text{MOD} \left( \frac{((\text{current position}) - (\text{horizontal position})) \times \frac{1}{(\text{defined unit})}}{256} \right)$$

The defined unit varies as follows:

ESC/P 2 printers      The unit defined with the ESC ( U command  
 Non-ESC/P2,

24/48-pin printers

    LQ mode    1/180 inch

    Draft mode 1/120 inch

9-pin printers      1/120 inch

**Note:**

- These commands have no effect on the vertical print position.
- The printer ignores commands that would move the print position outside the left or right margins.
- Character scoring (underline, overscore, and strikethrough) is not performed between the current and final print positions when the ESC \$ command is used. Scoring is also not performed if the ESC \ command moves the print position in the negative direction.

You can also use the tab command to move the horizontal print position to the next tab position.

First set the tabs with the ESC D command. The format of the ESC D command is as follows:

```
ESC D n1 n2 . . . nk NUL
```

Sets horizontal tab positions (in the current character pitch) at the columns specified by n<sub>1</sub> to n<sub>k</sub>, as measured from the left-margin position

**Note:**

- The values for n must be in ascending order; a value of n less than the previous n ends tab setting (just like the NUL code).
- Changing the character pitch does not affect current tab settings.
- Send an ESC D NUL command to cancel all tab settings.
- The tab settings move to match any movement in the left margin.
- A maximum of 32 horizontal tabs can be set.
- The printer does not move the print position to any tabs beyond the right-margin position. However, all tab settings are stored in the printer's memory; if you move the right margin, you can access previously ignored tabs.
- The printer calculates tab positions based on 10 cpi if proportional spacing is selected with the ESC p command.
- Sending the ESC D command clears any previous tab settings.

Sending the HT command moves the print position to the next tab position to the right of the current position.

**Note:**

- The HT command has no effect on the vertical print position.
- The printer ignores an HT command that would move the print position outside (to the right of) the right-margin position.
- Character scoring (underline, overscore, and strikethrough) is not performed between the current and final print positions when the HT command is sent.

## Moving the vertical position

ESC/P 2

For ESC/P 2 printers, the vertical print position is defined as follows:

- The position 20/180 inch above the baseline during character printing
- The position of the top printable row of dots during graphics printing

### Note:

When setting the vertical print position, you must place enough room at the top and bottom of a page for a full character to print.

If the point size is larger than 10.5 points, and the print position is near the top or bottom-margin position, part of the character may print outside the printing area (above the top-margin or below the bottom-margin position). The printer prints the full character, even though it falls outside the printing area, with the following exception:

If part of the character falls outside the printable area on single-sheet paper (closer than 8.5 mm to the top edge or closer than 13.5 mm to the the bottom edge), that part is not assured.

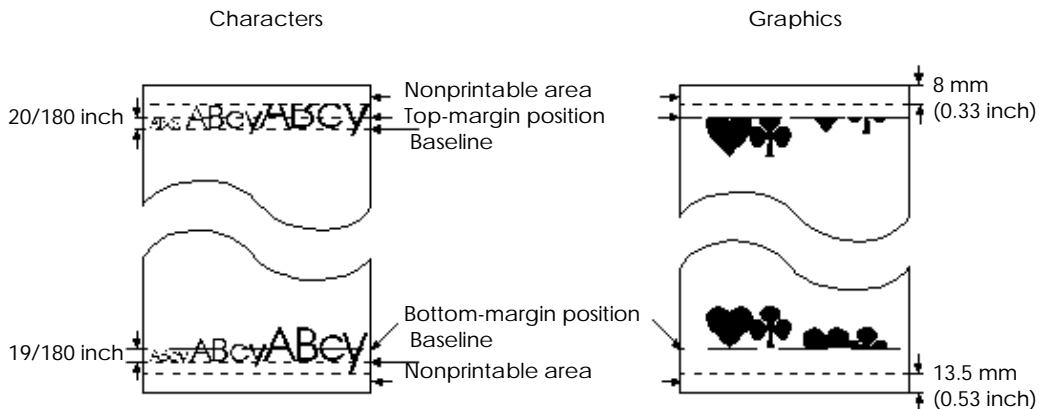

### Note:

- Always set the vertical print position so sufficient room is provided for the full character to print.
- Graphics data falling outside the printing area is ignored.

New commands are available in ESC/P 2 that simplify setting the vertical print position. These commands are:

ESC ( V	Set absolute vertical print position
ESC ( v	Set relative vertical print position

The unit of movement for both these commands is the unit set with the ESC ( U command. See ESC ( U in the Command Summary and “Setting the page length” for more information.

The format for the ESC ( V command is as follows:

ESC ( V 2 0 m<sub>L</sub> m<sub>H</sub>

The resulting vertical position is determined by the following formula:

$$(\text{vertical position}) = ((m_H \times 256) + m_L) \times (\text{defined unit}) + (\text{top-margin position})$$

$$m_H = \text{INT} \left( \frac{((\text{vertical position}) - (\text{top-margin position})) \times \frac{1}{(\text{defined unit})}}{256} \right)$$

$$m_L = \text{MOD} \left( \frac{((\text{vertical position}) - (\text{top-margin position})) \times \frac{1}{(\text{defined unit})}}{256} \right)$$

The format for the ESC ( v command is as follows:

ESC ( v 2 0 m<sub>L</sub> m<sub>H</sub>

$$(\text{horizontal position}) = ((m_H \times 256) + m_L) \times (\text{defined unit}) + (\text{current position})$$

To move in the positive direction (down the page), the formula is as follows:

$$m_H = \text{INT} \left( \frac{((\text{vertical position}) - (\text{current position})) \times \frac{1}{(\text{defined unit})}}{256} \right)$$

$$m_L = \text{MOD} \left( \frac{((\text{vertical position}) - (\text{current position})) \times \frac{1}{(\text{defined unit})}}{256} \right)$$

To move in the negative direction (up the page), the formula is as follows:

$$m_H = 32768 - \text{INT} \left( \frac{((\text{current position}) - (\text{vertical position})) \times \frac{1}{(\text{defined unit})}}{256} \right)$$

$$m_L = 32768 - \text{MOD} \left( \frac{((\text{current position}) - (\text{vertical position})) \times \frac{1}{(\text{defined unit})}}{256} \right)$$

**Note:**

- These commands have no effect on the horizontal print position.
- The printer ignores the ESC ( v command if it would move the print position above the top margin.
- If a command would move the print position below the bottom margin position, the print position moves to the top-margin position on the following page.
- You cannot move the print position more than 179/360 inch in the negative direction from the current print position.
- The printer ignores this command under the following conditions:
  - The command would move the print position more than 179/360inch in the negative direction
  - The command would move the print position in the negative direction after a graphics command is sent on the current line
  - The command would move the print position in the negative direction beyond the position of any previous graphics printing

ESC/P 2

9-Pin ESC/P

For Non-ESC/P 2 printers, the vertical position is defined as follows:

- The position 20/180 inch (7/72 inch for 9-pin printers) above the baseline during character printing
- The position of the top printable row of dots during graphics printing

The following commands are recommended for moving the vertical print position within a page.

ESC J	Advance the print position vertically
LF	Line feed

The format for the ESC J command is as follows:

ESC J n

This command moves the paper forward according to the following formula.

24/48-pin printers	(distance down) = n/180 inches
9-pin printers	(distance down) = n/216 inches

This command has no effect on the horizontal print position.

The LF command affects both the vertical and horizontal positions. Sending the LF command performs the following functions:

- Moves the print position one line forward in the currently selected line spacing
- Moves the horizontal print position to the left-margin position

**Note:**

Paper handling at the end of a page differs depending on paper type, loading method, and ESC/P version.

ESC/P 2

Continuous paper	If an ESC J, LF, ESC ( V, or ESC ( v command would move the print position below the bottom margin position, the printer moves the print position to the top-margin position on the following page.
Single-sheet paper	If an ESC J, LF, ESC ( V, or ESC ( v command would move the print position below the bottom-margin position, the printer ejects the sheet of paper.

ESC/P

9-Pin ESC/P

Continuous paper	If an ESC J or LF command would move the print position below the bottom-margin position, the printer moves the print position to the top-of-form position on the following page.
Single-sheet paper	
<i>Loaded by cut-sheet feeder</i>	If an ESC J or LF command would move the print position below the end of the printable area, the printer ejects the paper.
<i>Loaded by hand</i>	If an ESC J or LF command would move the print position below the end of the printable area, the printer feeds the paper until the end of the page. After the next sheet is loaded, the printer feeds the paper the remaining distance specified in the ESC J or LF command.

## Send Print Data

ESC/P 2

ESC/P

9-Pin ESC/P

Once you have set the page format, defined the starting characters, and set the initial print position, you can begin sending print data.

The following rules allow the printer to process data most efficiently.

- Send data from left to right on a line.
- End each line of data with a CR and LF command.
- Send lines from the top to the bottom of the page.
- Complete each page with a FF command. Also send a FF command at the end of each print job.

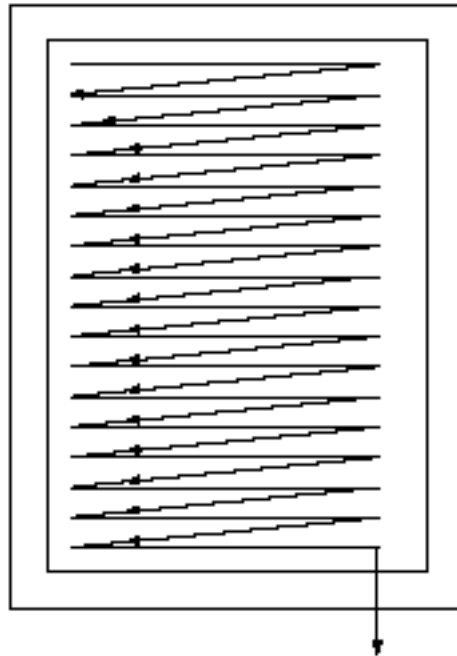

**Note:**

The exception to this data order is when you combine bit-image graphics with text printing. See “Mixing text and bit-image graphics” for details.

To vary printed characters, you can change font attributes and enhancements at any time. See the following sections for information on preparing and sending graphics data.

# Sending Graphics Data

ESC/P 2    ESC/P    9-Pin ESC/P

Two kinds of graphics printing are possible: bit-image and raster graphics. Although both types of graphics are based on bits in the data bytes, the relationship between the data order and dot printing differs.

## Bit Image

- Bit-image graphics was developed with the layout of the print head in mind. Data is organized to correspond to columns of print head output. Printing takes place after each complete line is sent.
- Bit-image graphics can be mixed with text printing.
- Bit-image graphics is available on all printers.

## Raster Graphics

- Raster graphics treats data in essentially the same way as video displays and laser printers. Data is sent in one-dot high lines. The printer reorganizes the data internally to correspond to the print head layout. Printing may not take place at the end of the line.
- There are two levels of raster graphics: standard and extended. Standard raster graphics is available only on ESC/P 2 printers. Extended raster graphics is available only on the Stylus COLOR and later high-resolution ESC/P 2 printer models.
- Standard raster graphics has a special data compression feature that allows you to economize on the data necessary to print graphics. Extended raster graphics provides two additional data compression schemes.
- Text and raster graphics printing cannot be combined on the same page.

The illustrations below show the difference between raster and bit-image data processing.

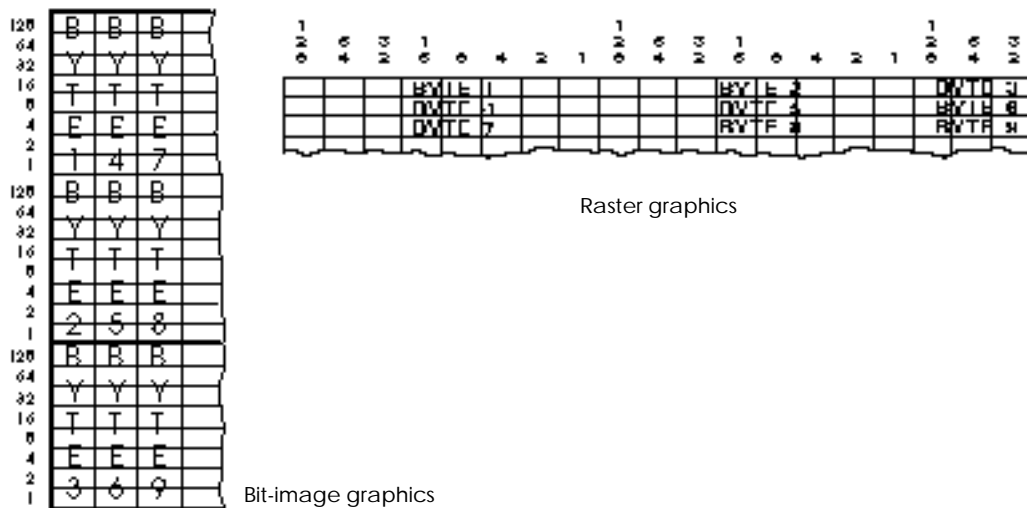

**Note:**

For detailed information on programming for EPSON's Stylus COLOR and other high-resolution color printers, see "Extended ESC/P 2 Programming Guide" at the end of this chapter.

To eliminate potential command conflicts during raster graphics printing, EPSON provides a special graphics mode. In this mode, some commands are not available. See "Graphics mode" for details.

**Bit-image graphics**

ESC/P 2

ESC/P

9-Pin ESC/P

Bit-image graphics is available on all printers. Data handling varies, however, depending on the number of pins in the print head.

The steps for printing bit-image graphics are as follows:

1. Determine vertical and horizontal dot density.
2. Prepare and organize bit-image data.
3. If you plan to send more than one line of graphics, set the line spacing to match the height of the print head.
4. Set the vertical and horizontal print position to the top left corner of the graphics line.
5. Send one line of bit-image data to the computer.
6. Complete the line with a CR and LF command.
7. Repeat steps 5 and 6 until the full graphics design is printed.

**Determining vertical and horizontal dot density**

ESC/P 2

ESC/P

9-Pin ESC/P

The ESC \* command is used to print bit-image graphics.

The format of this command is as follows:

ESC \* m n<sub>L</sub> n<sub>H</sub> d<sub>1</sub> d<sub>2</sub> . . . d<sub>k</sub>

m

Specifies the dot density and printing speed. The dot density can be specified from 60 × 60 dpi (dots per inch) to up to 360 × 360 dpi, depending on the number of pins in the print head. The printing speed depends on the printing of adjacent horizontal dots; by not allowing the printing of adjacent dots, you increase the printing speed.

$n_L, n_H$

Specifies the number of dot columns to follow, determined by the following equation:

$$(\text{number of dot columns}) = ((n_H \times 256) + n_L)$$

$$n_H = \text{INT} \frac{(\text{number of dot columns})}{256}$$

$$n_L = \text{MOD} \frac{(\text{number of dot columns})}{256}$$

The number of bytes required for each dot column shown below.

$d_1 \dots d_k$

Data bytes

You must specify the vertical and horizontal dot density of graphics when sending the ESC \* command. The dot densities available are shown in the table below.

*Dot density*

Parameter m in ESC * command	Horizontal density	Vertical density			Adjacent dot printing	Dots per column	Bytes per column
		9 pin	24 pin	48 pin			
0	60	72	60	60	Yes	8	1
1	120	72	60	60	Yes	8	1
2	120	72	60	60	No	8	1
3	240	72	60	60	No	8	1
4	80	72	60	60	Yes	8	1
5	72	72	N/A	N/A	Yes	8	1
6	90	72	60	60	Yes	8	1
7	144	72	N/A	N/A	Yes	8	1
32	60	N/A	180	180	Yes	24	3
33	120	N/A	180	180	Yes	24	3
38	90	N/A	180	180	Yes	24	3
39	180	N/A	180	180	Yes	24	3
40	360	N/A	180	180	No	24	3
64	60	N/A	N/A	360	Yes	48	6
65	120	N/A	N/A	360	Yes	48	6
70	90	N/A	N/A	360	Yes	48	6
71	180	N/A	N/A	360	Yes	48	6
72	360	N/A	N/A	360	No	48	6
73	360	N/A	N/A	360	Yes	48	6

**Note:**

If the mode you select does not allow adjacent dot printing, the printer ignores the second of two consecutive horizontal dots as shown below:

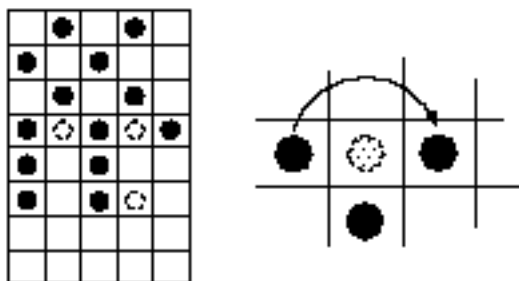

*Preparing bit-image data*

Once you have determined the dot density, create a grid for plotting your design. If the horizontal density is not the same as the vertical density, make a grid that reflects this.

See the sample grids below.

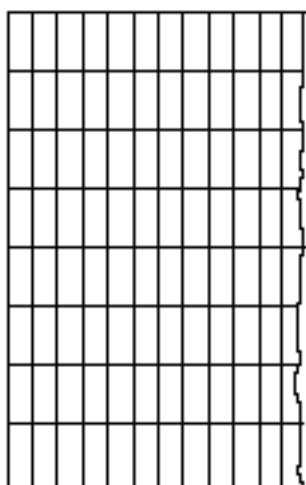

8-dot columns

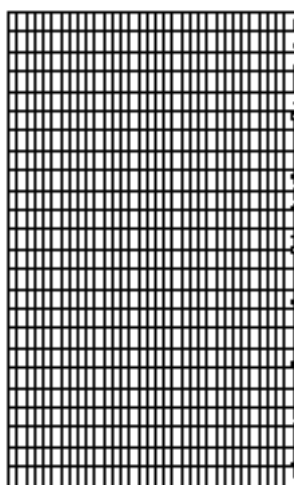

24-dot columns

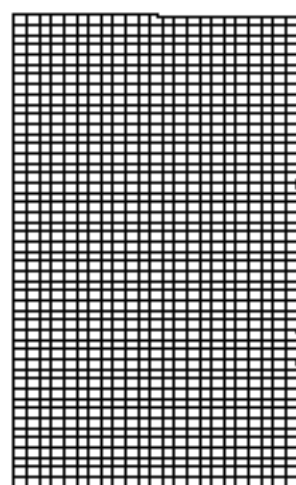

48-dot columns

Divide the grid into columns of 1, 3, or 6 bytes, depending on the m parameter of the dot density you select. The illustrations in the next two sections depict the following examples:

m = 0

60 × 60 dpi (60 × 72 dpi for 9-pin printers)

m = 39

180 × 180 dpi

m = 72

360 × 360 dpi

After plotting the design, divide the grid into groups one dot wide and eight dots high.

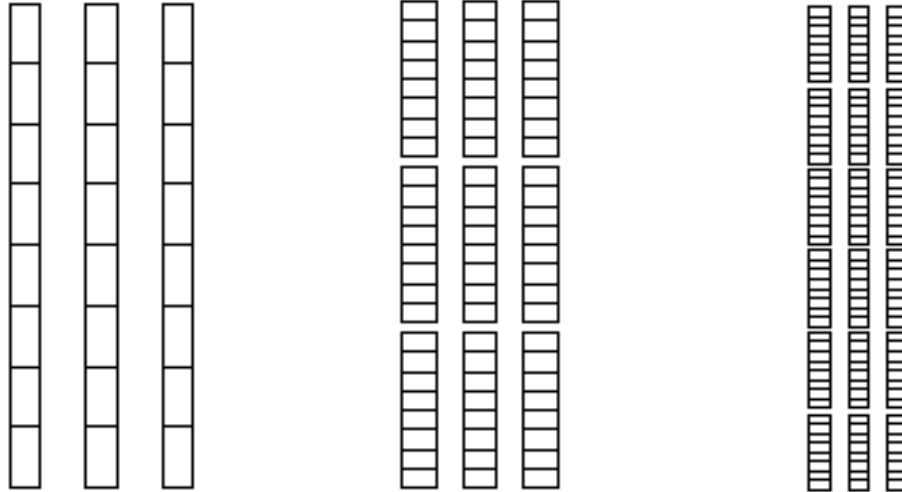

The dots in each group have a value, as shown in the following diagram. The sum of each group is sent as a byte of data to the printer. Calculate the value for each byte as shown.

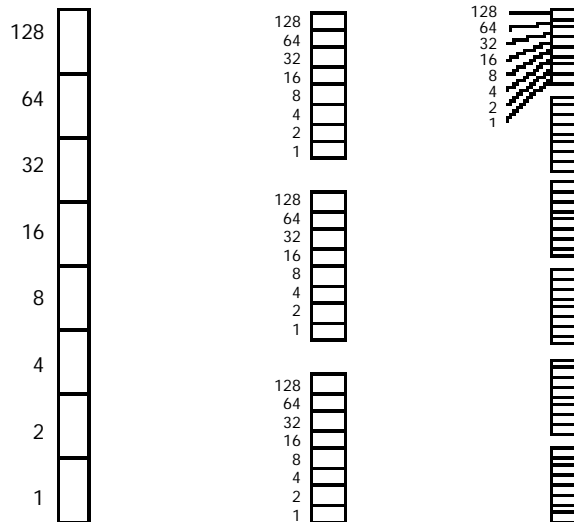

## Sending bit-image data to the printer

The order for sending data depends on the mode selected with the *m* parameter. The table at the beginning of this section lists the number of bytes of data required for each column.

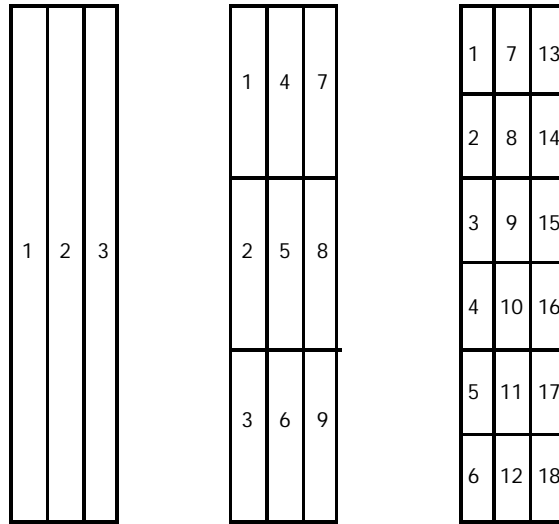

Count the number of resulting columns in each line. The  $n_L$  and  $n_H$  parameters tell the printer how many columns to expect. Calculate  $n_L$  and  $n_H$  as follows:

$$n_H = \text{INT} \frac{(\text{number of dot columns})}{256}$$

$$n_L = \text{MOD} \frac{(\text{number of dot columns})}{256}$$

If you are going to send more than one line of graphics, send the following commands to set the line spacing:

24/48-pin printers	ESC + 48	48/360-inch line spacing
9-pin printers	ESC 3 24	24/216-inch line spacing

This matches the line spacing to the height of the print head. After this, sending the CR and LF commands moves the vertical print position so the next line of graphics begins right where the previous line ended, with no space between.

Now send the data for the first line to the printer as follows:

ESC \* 0  $n_L$   $n_H$   $d_1$   $d_2$  . . .  $d_k$

ESC \* 39  $n_L$   $n_H$   $d_1$   $d_2$  . . .  $d_k$

ESC \* 72  $n_L$   $n_H$   $d_1$   $d_2$  . . .  $d_k$

At the end of the line, send the CR and LF commands. Move the horizontal print position as necessary. Then send the ESC \* command for the next line of graphics.

**Note:**

- Since the vertical dot density during 8-dot mode is different for 9 and 24/48-pin printers, printed graphics will differ slightly (graphics on 9-pin printers will appear slightly compressed vertically).
- You must send the ESC \* command for each line of graphics.

### *Mixing text and bit-image graphics with ESC/P 2 printers*

#### ESC/P 2

ESC/P 2 printers can process more than one line of data at a time; this allows for advanced features such as scalable fonts and raster graphics.

More memory has been provided for processing data than previous ESC/P versions. By processing data within this memory before printing, mixing bit-image graphics and text of all point sizes is possible.

To provide the most efficient processing of data in the memory available, ESC/P 2 has the following rules:

- You cannot move the vertical print position more than 179/360 inch (one dot less than 1/2 inch) in the negative direction.
- You cannot move the vertical print position in the negative direction if you have just sent graphics data, or if the print position would move above previously printed graphics data.

Because of these rules, you should process data with text data always leading graphics data by 1/2 inch.

Follow the steps below for this process.

1. Use the ESC + 48 command to set the line spacing to match the print head height.
2. Send the first 1/2 inch of text data to the printer. You can print any combination of fonts (large and small point sizes, etc.) on multiple lines; however, make sure the baseline of all characters is located within this 1/2-inch.
3. Use the ESC ( V or ESC ( v commands to move the print position to the top of the 1/2-inch zone.
4. Use the ESC \* command to send one line of graphics data (see the previous section). End the graphics line with the CR and LF commands. Note that the height of one line of graphics is equal to the height of the print head (48/360-inch).

5. Move the vertical print position to the bottom of the 1/2-inch zone.
6. Send all text data that has its baseline located in the next 48/360-inch band.
7. Move the vertical print position to 1/360 inch below the bottom of the previous line of graphics.
8. Continue sending alternating 48/360-inch bands of text, then data, with the text leading the graphics by 1/2 inch (as described in steps 4 to 7).
9. When you reach the end of the text data, or the page's bottom margin, send all the remaining lines of graphics data.

This order allows the printer to store text data in its memory first. Then, when you send the graphics data, the printer prints out the combined data.

**Note:**

If you don't follow this order, the tops of some characters may be cut off. This can occur when part of a character overlaps previously printed graphics.

## Graphics mode

ESC/P 2

ESC/P 2 printers feature a method of printing graphics, called raster graphics. To prevent conflicts with existing commands, EPSON uses a special graphics mode. You can send raster graphics commands only when in this mode.

Raster graphics gives the programmer a simple, consistent method of printing bit-map images. Raster graphics provides the following advantages:

- Prints images in a consistent manner, regardless of the print head configuration (24 or 48 pins)
- Eliminates necessity for interleaving lines to achieve maximum dot density
- Eliminates complicated calculations for handling data in specific band heights
- Provides for data compression; two bytes of data (a counter byte and a data byte) can specify up to 1,016 dots. Also, repetitive and nonrepetitive data can be sent in the same data string.

Standard raster graphics commands are available to all ESC P/2 printers. An additional set of raster graphics commands, known as extended raster graphics, was developed for EPSON's line of high-resolution color ink jet printers. This new set of commands provides one additional compressed raster graphics mode, which can be accessed by sending the ESC . 2 command.

## Entering and exiting graphics mode

ESC/P 2

Graphics mode is entered by sending the ESC ( G command. The format of the command is as follows:

ESC ( G 1 0 1

You can only enter graphics mode with this command. Use the ESC @ (initialize printer) command to exit graphics mode.

## Commands available in graphics mode

Only the following commands are available in standard raster graphics mode:

LF	Line feed
CR	Carriage return
ESC .	Print raster graphics
ESC . 1	Enter RLE compressed mode
ESC . 2	Enter TIFF compressed mode (Stylus COLOR only)
ESC ( c	Set page format
ESC ( V	Set absolute vertical position
ESC \$	Set absolute horizontal position
ESC r	Select printing color
ESC +	Set n/360-inch line spacing
FF	Form feed
ESC EM	Control paper loading/ejecting
ESC @	Initialize printer (exit graphics mode)
ESC ( C	Set page length in defined unit
ESC ( v	Set relative vertical position
ESC \	Set relative horizontal position
ESC U	Turn unidirectional on/off
ESC ( U	Set unit
ESC ( i	MicroWeave (Stylus COLOR only)

The following subset of binary mode commands is available in extended raster graphics mode, entered by sending the ESC . 2 command. All other commands are ignored.

<XFER>	Transfer raster graphics data
<MOVX>	Set relative horizontal position
<MOVY>	Set relative vertical position
<COLR>	Select printing color
<CR>	Carriage return to left-most print position
<EXIT>	Exit TIFF compressed mode
<MOVXBYTE>	Set <MOVX> unit to 8 dots
<MOVXDOT>	Set <MOVX> unit to 1 dot

Other commands not listed above are ignored. Also, text cannot be sent during graphics mode.

## Standard raster graphics

ESC/P 2

Raster graphics allows the programmer to send image data in a format similar to that used by televisions, VDT monitors, and laser printers.

Follow these steps to prepare and send raster graphics:

1. Determine the dot density (resolution) of your image.

2. Use the ESC ( U command to set the unit to match the vertical dot density selected.
3. Divide your image into bands. These bands should be 1, 8, or 24-dots high. Parameter m in the ESC . command should be set to this value.
4. Use the ESC + command to set line spacing to match the height of the vertical band. If you select 360-dpi dot density, the parameter for the ESC + command is the same as parameter m in the ESC . command. If you select 180, the ESC + parameter equals  $m \times 2$ .
5. Set the vertical and horizontal positions to begin the first graphics band.
6. Use the ESC . command to send a graphics band m dots high.
7. Send the CR and LF commands at the end of each block; then move the horizontal position to the beginning of the next graphics band.
8. Repeat steps 6 and 7 until all graphics data is sent for the page.
9. Send a FF command at the end of the page.
10. Repeat steps 6 to 9 for all pages in the print job.

The format of the ESC . (standard raster graphics) command is as follows:

ESC . c v h m n<sub>L</sub> n<sub>H</sub> d<sub>1</sub> d<sub>2</sub> . . . d<sub>k</sub>

c = 0                      Selects full graphics mode; all data bytes are treated as print data

1                            Selects run length encoded compressed mode; data treated as follows: counter byte, data, counter byte, data

v                            Specifies vertical dot density (independent of number of pins in head)

$$(\text{vertical dot density}) = \frac{3600}{v} \text{ dpi}$$

h                            Specifies horizontal dot density (independent of number of pins in head)

$$(\text{horizontal dot density}) = \frac{3600}{h} \text{ dpi}$$

m                            Specifies vertical dot count (1, 8, or 24)

n<sub>L</sub>, n<sub>H</sub>                    Specifies horizontal dot count

$$(\text{horizontal dot count}) = ((n_H \times 256) + n_L)$$

d<sub>1</sub> . . . d<sub>k</sub>                Data or counter/data combination

The vertical and horizontal dot densities that can be selected are as follows:

h	v	horizontal density	vertical density
20	20	180	180
10	20	360	180
10	10	360	360

Once you have decided the dot density, use the ESC ( U to set the unit to match the vertical dot density.

ESC ( U 1 0 10                      Selects 1/360-inch unit  
 ESC ( U 1 0 20                      Selects 1/180-inch unit

Next, create a grid for plotting your design. If the horizontal density is not the same as the vertical density, make a grid that reflects this.

See the sample grid below.

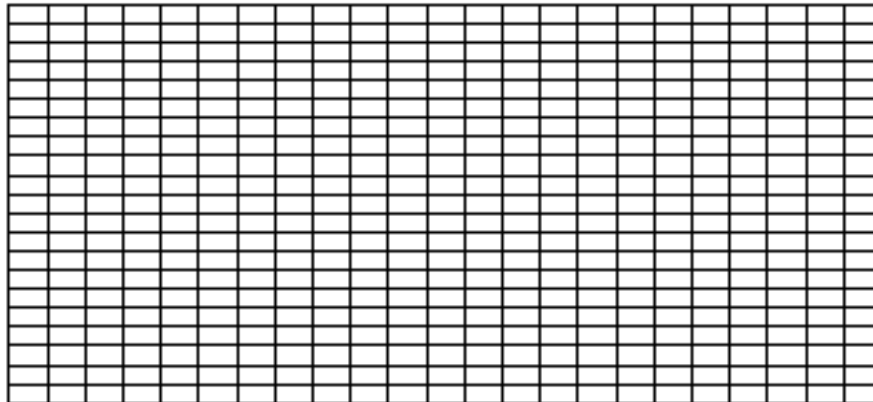

After plotting the design, divide the grid into groups one dot high and eight dots wide.

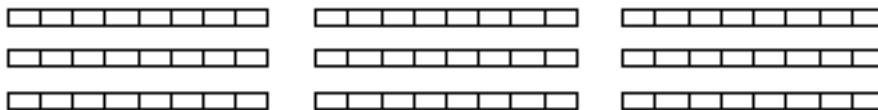

The dots in each group have a value, as shown in the following diagram. Calculate the value for each group as shown.

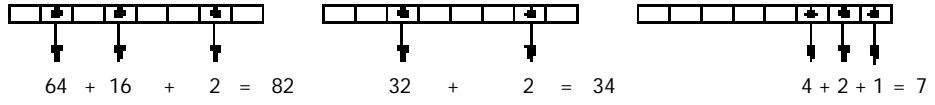

Divide your image into bands 1, 8, or 24-dots high. The number of vertical dots is called the band height. This is the value you should use for parameter `m` in the `ESC .` command.

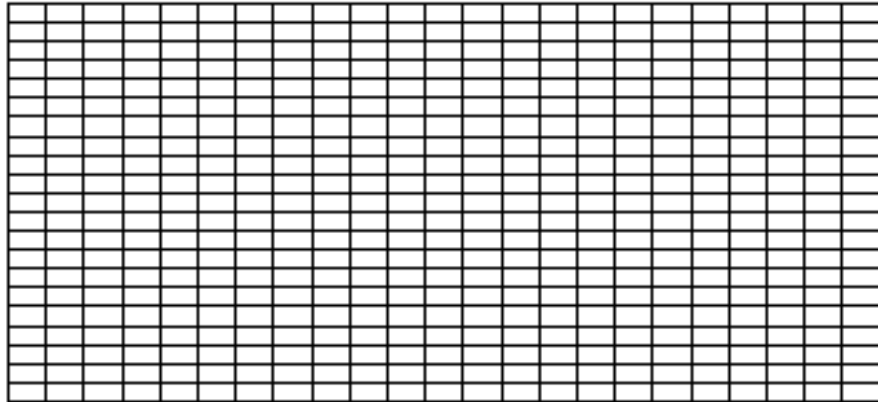
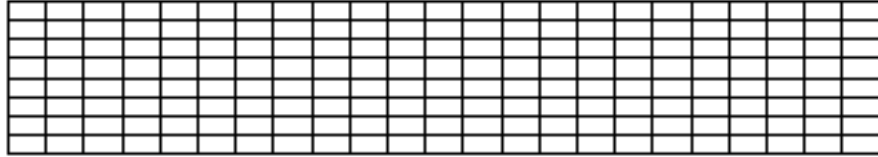

The band height affects the following:

- The taller the band height, the more memory you must prepare in your program to accommodate graphics data.
- The band height determines the number of times you must send the ESC . command. You must resend the ESC . command for each band of graphics you print. The taller the band height, the less number of ESC . commands you need to send.

The following table gives you an idea of how much memory is required for band heights at certain standard widths.

Band width	Bytes required for band heights at 180-dpi horizontal dot density			Bytes required for band heights at 360-dpi horizontal dot density		
	1-dot band height	8-dot band height	24-dot band height	1-dot band height	8-dot band height	24-dot band height
8 inches	180	1,440	4,320	360	2,880	8,640
11 inches	248	1,984	5,952	495	3,960	11,880
14 inches	315	2,520	7,560	630	5,040	15,120

Use the ESC + command to set line spacing to match the band height. The following table shows the command format for each band height.

ESC + command setting	Vertical dot density (dpi)	Band height (dots)	Band height (inches)	Parameter m in ESC . command
ESC + 1	360	1	1/360	1
ESC + 2	180	1	2/360	1
ESC + 8	360	8	8/360	8
ESC + 16	180	8	16/360	8
ESC + 24	360	24	24/360	24
ESC + 48	180	24	48/360	24

Before sending data, you must also determine the width of your graphics image. The width is also specified in number of dots. Of course, data must be sent in bytes; all data beyond the dot width specified is ignored.

The following illustration shows the dot width and the ignored data.

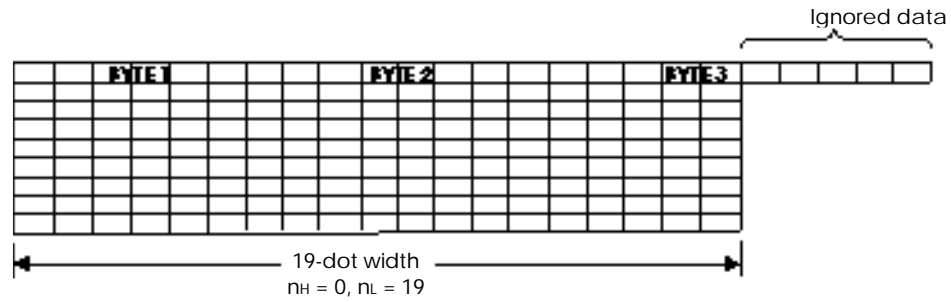

Determine the dot-width parameters for the ESC . command as follows:

$$n_H = \text{INT} \frac{(\text{dot width})}{256}$$

$$n_L = \text{MOD} \frac{(\text{dot width})}{256}$$

Use a combination of the ESC ( V, ESC ( v, ESC \$, or ESC \ commands to set the beginning position of the first graphics band. The print position corresponds to the position of the first printable dot in your image.

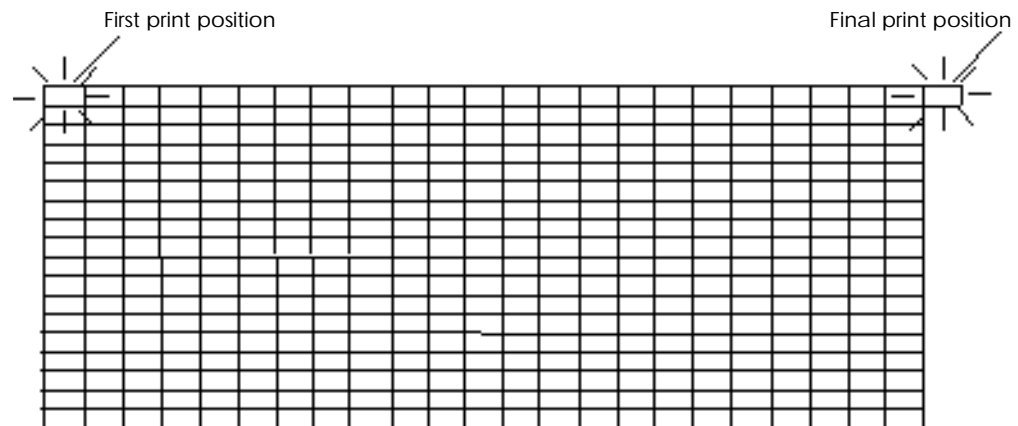

You are now ready to send data with the ESC . command.

The method of sending data in standard raster graphics mode depends on whether you select full graphics (ESC.0) or compressed mode (ESC . 1). For a discussion of extended raster graphics compressed modes, see “Extended raster graphics (ESC . 2).”

### Full graphics mode (ESC . 0)

#### ESC/P 2

If you set the ESC . command’s parameter *c* to 0, you select full graphics mode. During full graphics mode, all data received is treated as print data.

**Note:**

Full graphics mode requires more data to be sent. Use compressed raster graphics mode whenever possible.

During full graphics mode, simply divide the image grid into bytes and send the bytes one after another, in the following order.

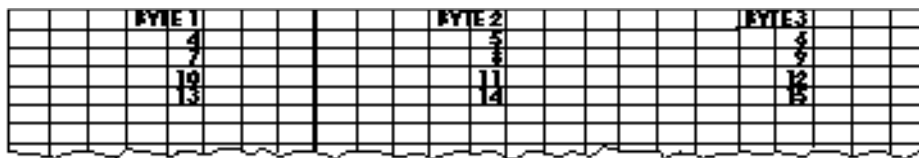

After sending the data for the graphics band, send a CR and LF command.

ESC/P 2

The method of sending data in standard raster graphics compressed mode is slightly more complicated. However, the amount of data necessary to print graphics may be greatly reduced. When possible, you should use one of the available compressed modes. For information on extended raster graphics compressed modes, see “Extended raster graphics (ESC . 2).”

Data is organized as counter bytes followed by data bytes. Two types of counters can be used: repeat counters and data-length counters.

*Repeat counters* specify the number of times (minus 1) to repeat the following single byte of data.

*Data-length counters* specify the number of bytes (minus 1) of print data following the counter. This data is printed only once.

If the counter is positive, it is treated as a data-length counter.

$$0 \leq (\text{data-length counter}) \leq 127$$

The data-length counter is calculated as follows:

$$(\text{data-length counter}) = (\text{number of data bytes to follow}) - 1$$

If the counter is negative (as determined by two’s complement), it is treated as a repeat counter.

$$-1 \leq (\text{repeat counter}) \leq -127$$

The repeat counter is calculated as follows:

$$(\text{repeat counter}) = 256 - (\text{number of times to repeat data}) + 1$$

During compressed mode, the first byte of data must be a counter. After receiving a counter, the printer handles data as follows:

If a repeat counter is received, the printer repeats the following byte of data the specified number of times. The byte following the data byte is treated as a counter.

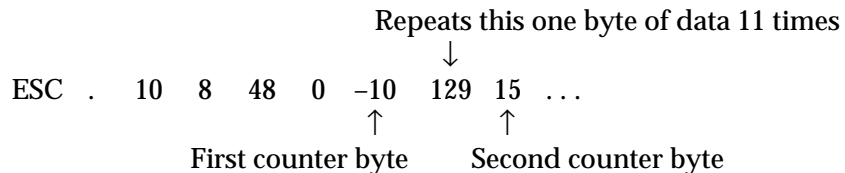

If a data-length counter is received, the printer prints the specified number of bytes. The next byte following the data is treated as a counter.

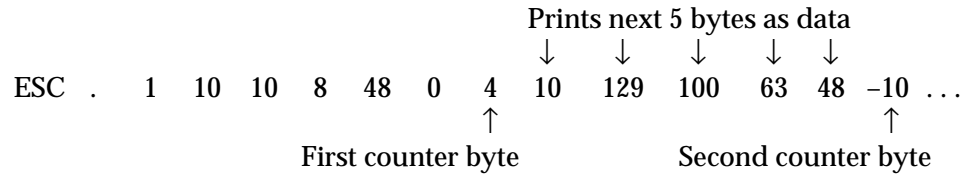

Since the printer evaluates each counter separately, you can include both kinds of counters in the same ESC . 1 command sequence. However, the total amount of print data must match the length and height of the graphics band.

**Note:**

If your image has consecutive blank spaces, use the repeat counter to send repetitive bytes of NUL data (bytes with value of 0). This can greatly reduce the amount of data necessary for printing some images.

During compressed mode, divide the image grid into bytes just as with full graphics mode. However, you then separate repetitive data bytes from nonrepetitive bytes. Shaded areas indicate repetitive data bytes.

60	90	30	128	37	79	42	15	53
14	99	155	155	63	97	22	0	0
0	0	60	15	15	15	15	15	128
32	9	27	34	173	91	92	8	0
0	0	0	0	0	0	0	0	0
0	0	37	14	16	88	103	77	61
13	25	155	155	63	97	22	31	97
44	110	109	15	15	15	15	15	0

The ESC . 1 command would be as follows for the example above.

ESC . 1 10 10 8 72 0

After sending the following data (shaded data bytes are counters), send a CR or LF command.

15	60	90	30	128	37	79	42
15	53	14	99	155	155	63	97
22	-3	0	0	60	-4	15	8
128	32	9	27	34	173	91	92
8	-11	0	18	37	14	16	88
103	77	61	13	25	155	155	63
97	22	31	97	44	110	109	-4
15	0	0					

## Extended raster graphics (ESC . 2)

ESC/P 2

Extended raster graphics provides one data compression mode: TIFF (ESC . 2). For more information on programming with this command, see “Extended ESC/P 2 Programming Guide” later in this section.

A brief explanation of each mode is given below.

### *TIFF compressed mode (ESC . 2)*

Uses the TIFF compression format. Image data for each color is written to the band buffer (of the current line) and has no effect on the next line. Image data must be sent for each line. The compression method is the same as that used in the RLE compressed mode (ESC . 1), which means that image data is sent in the “counter + image data” format. Although both compression methods use the same amount of image data, the amount of code data required by each method varies markedly. The TIFF mode uses a subset of binary commands that require much less data than the corresponding ESC commands used in the RLE mode. For example, the print position, color selection, and other operation codes can be specified with only 1 to 3 bytes in the TIFF mode, thereby reducing the overall amount of data sent to the printer. The TIFF mode provides a good balance between data handling speed and the amount of data compression, making it ideal for printing small graphics files.

An example of the data compression methods used in extended raster graphics mode is shown below. For more information, see the explanation of each command in Individual Command Descriptions.

Sample graphics image (3 lines, 3 × 24 dots)

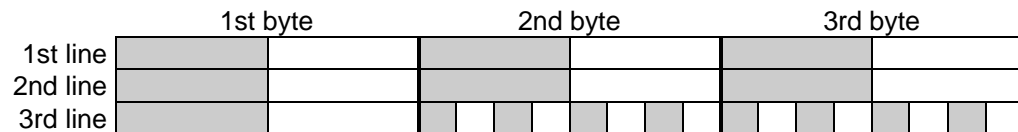

Sample graphics image expressed as byte data

	1st byte	2nd byte	3rd byte
1st line	F0H	F0H	F0H
2nd line	F0H	F0H	F0H
3rd line	F0H	AAH	AAH

### *TIFF compressed mode*

After sending ESC . 2 v h 1 0 0 (8 bytes) once to enter TIFF compressed mode, following data is sent in the “binary code data + image data” format, and can be used to print several lines. In this mode, all image data must be sent again even if the following line is identical to the previous one. For example, to print the first and second lines in the above example, 4 bytes (3 × F0H (twice)) of image data are needed. The total amount of data used to send the graphics image sample shown above is as follows:

2 bytes (image data of 1st line) + 9 bytes (code data of 1st line) + 2 bytes (image data of 2nd line) + 2 bytes (code data of 2nd line) + 4 bytes (image data of 3rd line) + 2 bytes (code data of 3rd line) = 21 bytes

## Printing Bar Codes

ESC/P 2

ESC/P

9-Pin ESC/P

Barcode print is available on DLQ-3000('96-), LQ-670, LQ-2070, LQ-2170, FX-2170 and later impact dot matrix models.

The ESC ( B command is used to print barcodes. The format of this command is as follows:

ESC ( B  $n_L$   $n_H$   $k$   $m$   $s$   $v_1$   $v_2$   $c$  BarCodeData

$n_L$   $n_H$  Specify the number of data bytes to follow, determined by the following equation:

$$(\text{number of data bytes}) = 6 \text{ bytes} + \text{BarCodeData bytes} = ((n_H \times 256) + n_L)$$

(where 6 bytes are  $k$ ,  $m$ ,  $s$ ,  $v_1$ ,  $v_2$ , and  $c$ )

$$n_H = \text{INT} \frac{(\text{number of data bytes})}{256}$$

$$n_L = \text{MOD} \frac{(\text{number of data bytes})}{256}$$

The parameter  $k$  specifies the barcode type.

k (Hex)	Bar code type
00	EAN-13
01	EAN-8
02	Interleaved 2 of 5
03	UPC-A
04	UPC-E
05	Code 39
06	Code 128
07	POSTNET

The parameter  $m$  specifies the module width.

$m$	24-pin printer (unit 1/180 inch)	9-pin printer (unit 1/120 inch)
02 (default)	2 dots	2 dots
03	3 dots	3 dots
04	4 dots	4 dots
05	5 dots	5 dots

The parameter  $s$  specifies the space adjustment value.

24-pin printer	$-3 \leq s \leq 3$ (unit 1/360 inch)
9-pin printer	$-3 \leq s \leq 3$ (unit 1/240 inch)

The parameter  $v_1$  and  $v_2$  specifies the bar length.

24-pin printer	bar length = $v_1 + v_2 \times 256$ (unit 1/180 inch)
9-pin printer	bar length = $v_1 + v_2 \times 256$ (unit 1/72 inch)

The limitation of bar length:

$$45/180 \text{ inch} \leq \text{bar length} \leq 22 \text{ inch} \quad : \text{24-pin printer}$$

$$18/72 \text{ inch} \leq \text{bar length} \leq 22 \text{ inch} \quad : \text{9-pin printer}$$

The  $v_1$  and  $v_2$  values are ignored when POSTNET is selected.

Long bar length of POSTNET is always 0.125 inch.

Short bar length of POSTNET is always 0.050 inch.

The parameter **c** specifies the control flag.

c	Control flag
bit 0	Check digit 0: If check digit is to be printed, the host generates it and sends it to the printer 1: Printer generates and prints the check digit
Bit 1	Human readable character 0: Prints 1: Does not print
Bit 2	Position of flag character (for EAN-13 and UPC-A only) 0: Center 1: Under
bit 3	(reserved)
bit 4	(reserved)
bit 5	(reserved)
bit 6	(reserved)
bit 7	(reserved)

**Barcode Data** Corresponds to the bar code symbology.  
The data number of each bar code type is constant.  
The bar code is not printed if the number of bar code characters are incorrect.

Bar code type	Actual number of Barcode Data (HEX)	
	control flag c bit 0 = 0	control flag c bit 0 = 1
EAN-13	0D	0C
EAN-8	08	07
Interleaved 2 of 5	02 to FF	02 to FF
UPC-A	0C	0B
UPC-E	0C or 8	0B or 7
Code 39	01 to FF	01 to FF
Code 128	02 to FF	02 to FF
POSTNET	06 or 0A or 0C	05 or 09 or 0B

The valid data of each bar code type are as follows.  
If invalid data is included in the Barcode Data string, the bar code is not printed.

Bar code type	Valid range of BarCodeData
EAN-13	0-9 (30H-39H)
EAN-8	0-9 (30H-39H)
Interleaved 2 of 5	0-9 (30H-39H)
UPC-A	0-9 (30H-39H)
UPC-E	0-9 (30H-39H)
Code 39	0-9 (30H-39H), (41H-5AH) (20H, 24H, 25H, 2BH, 2DH, 2EH, 2FH)
Code 128	See the code sets A, B, and C on the following pages.
POSTNET	0-9 (30H-39H)

Data Character Set A:

Character	Hex Code	Character	Hex Code	Character	Hex Code	Character	Hex Code
NUL	x00	Space	x20	'@'	x40	FNC 3	x60
OH	x01	'!'	x21	'A'	x41	FNC 2	x61
STX	x02	""	x22	'B'	x42	Shift	x62
EXT	x03	'#'	x23	'C'	x43	Code C	x63
EOT	x04	'\$'	x24	'D'	x44	Code B	x64
ENO	x05	'%'	x25	'E'	x45	FNC 4	x65
ACK	x06	'&'	x26	'F'	x46	FNC 1	x66
BEL	x07	""	x27	'G'	x47	—	—
BS	x08	'('	x28	'H'	x48	—	—
HT	x09	')'	x29	'I'	x49	—	—
LF	x0A	**	x2A	'J'	x4A	—	—
VT	x0B	'+'	x2B	'K'	x4B	—	—
FF	x0C	','	x2C	'L'	x4C	—	—
CR	x0D	','	x2D	'M'	x4D	—	—
SO	x0E	','	x2E	'N'	x4E	—	—
SI	x0F	','	x2F	'O'	x4F	—	—
DLE	x10	'0'	x30	'P'	x50	—	—
DC1	x11	'1'	x31	'Q'	x51	—	—
DC2	x12	'2'	x32	'R'	x52	—	—
DC3	x13	'3'	x33	'S'	x53	—	—
DC4	x14	'4'	x34	'T'	x54	—	—
NAK	x15	'5'	x35	'U'	x55	—	—
SYN	x16	'6'	x36	'V'	x56	—	—
ETB	x17	'7'	x37	'W'	x57	—	—
CAN	x18	'8'	x38	'X'	x58	—	—
EM	x19	'9'	x39	'Y'	x59	—	—
SUB	x1A	':'	x3A	'Z'	x5A	—	—
ESC	x1B	':'	x3B	'['	x5B	—	—
FS	x1C	'<'	x3C	'\'	x5C	—	—
GS	x1D	'='	x3D	']'	x5D	—	—
RS	x1E	'>'	x3E	'^'	x5E	—	—
US	x1F	'?'	x3F	'_'	x5F	—	—

Data Character Set B:

Character	Hex Code	Character	Hex Code	Character	Hex Code	Character	Hex Code
		Space	x20	'@'	x40		x60
		'!'	x21	'A'	x41	'a'	x61
		"	x22	'B'	x42	'b'	x62
		'#'	x23	'C'	x43	'c'	x63
		'\$'	x24	'D'	x44	'd'	x64
		'%'	x25	'E'	x45	'e'	x65
		'&'	x26	'F'	x46	'f'	x66
		"	x27	'G'	x47	'g'	x67
		'('	x28	'H'	x48	'h'	x68
		')'	x29	'I'	x49	'i'	x69
		**	x2A	'J'	x4A	'j'	x6A
		'+'	x2B	'K'	x4B	'k'	x6B
		','	x2C	'L'	x4C	'l'	x6C
		','	x2D	'M'	x4D	'm'	x6D
		','	x2E	'N'	x4E	'n'	x6E
		'/'	x2F	'O'	x4F	'o'	x6F
		'0'	x30	'P'	x50	'p'	x70
		'1'	x31	'Q'	x51	'q'	x71
		'2'	x32	'R'	x52	'r'	x72
		'3'	x33	'S'	x53	's'	x73
		'4'	x34	'T'	x54	't'	x74
		'5'	x35	'U'	x55	'u'	x75
		'6'	x36	'V'	x56	'v'	x76
		'7'	x37	'W'	x57	'w'	x77
		'8'	x38	'X'	x58	'x'	x78
FNC 3	x19	'9'	x39	'Y'	x59	'y'	x79
FNC 2	x1A	':'	x3A	'Z'	x5A	'z'	x7A
Shift	x1B	':'	x3B	'['	x5B	'{'	x7B
Code C	x1C	'<'	x3C	'\'	x5C	'/'	x7C
FNC 4	x1D	'='	x3D	']'	x5D	'}'	x7D
Code A	x1E	'>'	x3E	'^'	x5E	'~'	x7E
FNC 1	x1F	'?'	x3F	'_'	x5F	DEL	x7F

Data Character Set C:

Character	Hex Code	Character	Hex Code	Character	Hex Code	Character	Hex Code
'00'	x3030	'32'	x3332	'64'	x3634	'96'	x3936
'01'	x3031	'33'	x3333	'65'	x3635	'97'	x3937
'02'	x3032	'34'	x3334	'66'	x3636	'98'	x3938
'03'	x3033	'35'	x3335	'67'	x3637	'99'	x3939
'04'	x3034	'36'	x3336	'68'	x3638	Code B	x3A
'05'	x3035	'37'	x3337	'69'	x3639	Code A	x3B
'06'	x3036	'38'	x3338	'70'	x3730	FNC 1	x3C
'07'	x3037	'39'	x3339	'71'	x3731	—	—
'08'	x3038	'40'	x3430	'72'	x3732	—	—
'09'	x3039	'41'	x3431	'73'	x3733	—	—
'10'	x3130	'42'	x3432	'74'	x3734	—	—
'11'	x3131	'43'	x3433	'75'	x3735	—	—
'12'	x3132	'44'	x3434	'76'	x3736	—	—
'13'	x3133	'45'	x3435	'77'	x3737	—	—
'14'	x3134	'46'	x3436	'78'	x3738	—	—
'15'	x3135	'47'	x3437	'79'	x3739	—	—
'16'	x3136	'48'	x3438	'80'	x3830	—	—
'17'	x3137	'49'	x3439	'81'	x3831	—	—
'18'	x3138	'50'	x3530	'82'	x3832	—	—
'19'	x3139	'51'	x3531	'83'	x3833	—	—
'20'	x3230	'52'	x3532	'84'	x3834	—	—
'21'	x3231	'53'	x3533	'85'	x3835	—	—
'22'	x3232	'54'	x3534	'86'	x3836	—	—
'23'	x3233	'55'	x3535	'87'	x3837	—	—
'24'	x3234	'56'	x3536	'88'	x3838	—	—
'25'	x3235	'57'	x3537	'89'	x3839	—	—
'26'	x3236	'58'	x3538	'90'	x3930	—	—
'27'	x3237	'59'	x3539	'91'	x3931	—	—
'28'	x3238	'60'	x3630	'92'	x3932	—	—
'29'	x3239	'61'	x3631	'93'	x3933	—	—
'30'	x3330	'62'	x3632	'94'	x3934	—	—
'31'	x3331	'63'	x3633	'95'	x3935	—	—

## Print position:

A bar code is placed the left upper end of a bar code to the current vertical and horizontal print position. Also printing position after the printing of a bar code returns to the print position before bar code printing.

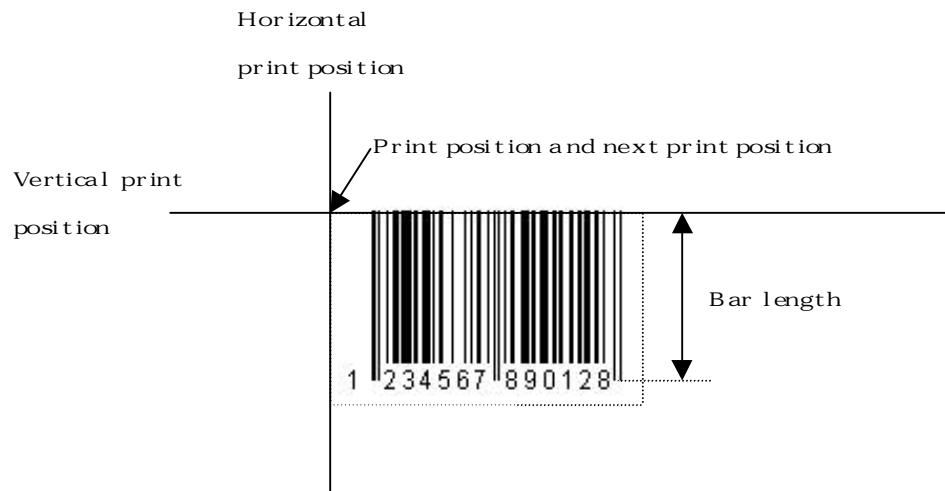

## Notes:

- (1) Bar code printing is always performed uni-directionally.
- (2) The bar code is not printed when part of the bar code is past the right margin.
- (3) Start/stop characters(\*) of Code39 are generated automatically by the printer, and added to human readable characters.
- (4) A kind of Code 128 character sets (A, B or C) is identified by the first data of Code 128. The first data must be a hexadecimal 41 (A), 42 (B) and 43 (C).
- (5) When Code 128 Character Set C and Interleaved 2 of 5 is selected and the number of Barcode data are ODD, "0" is added to the data string.

Examples:

example 1: EAN-13, CD: Host, HRI: print, Flag Char.: center

(CD: Check digit, HRI: Human Readable character)

1B 28 42 13 00 ; Barcode command and data length  
00 ; Barcode type **k** = EAN-13  
02 ; Module width **m** = 2 dots / 180 inch  
00 ; Space adjustment value **s** = +0 dots / 360 inch  
7D 00 ; Bar length **v1**, **v2** = 125 / 180 inch  
00 ; Control flags **c**  
30 31 32 33 34 35 36 ; Barcode Data  
37 38 39 30 31 32 ;



example 2: EAN-13, CD: Printer, HRI: print, Flag Char.: under

1B 28 42 12 00 ; Barcode command and data length  
00 ; Barcode type **k** = EAN-13  
02 ; Module width **m** = 2 dots / 180 inch  
00 ; Space adjustment value **s** = +0 dots / 360 inch  
7D 00 ; Bar length **v1**, **v2** = 125 / 180 inch  
05 ; Control flags **c**  
31 32 33 34 35 36 ; Barcode Data  
37 38 39 30 31 32



example 3: EAN-13, CD: Printer, HRI: none, Flag Char.: under

1B 28 42 12 00 ; Barcode command and data length  
00 ; Barcode type **k** = EAN-13  
02 ; Module width **m** = 2 dots / 180 inch  
00 ; Space adjustment value **s** = +0 dots / 360 inch  
7D 00 ; Bar length **v1**, **v2** = 125 / 180 inch  
03 ; Control flags **c**  
31 32 33 34 35 36 ; Barcode Data  
37 38 39 30 31 32

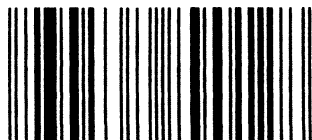

example 4: EAN-8, CD: Host, HRI: print

1B 28 42 0E 00 ; Barcode command and data length  
01 ; Barcode type **k** = EAN-8  
02 ; Module width **m** = 2 dots / 180 inch  
00 ; Space adjustment value **s** = +0 dots / 360 inch  
7D 00 ; Bar length **v1**, **v2** = 125 / 180 inch  
00 ; Control flags **c**  
30 31 32 33 34 35 36 35 ; Barcode Data



example 5: EAN-8, CD: Printer, HRI: none

1B 28 42 0D 00 ; Barcode command and data length  
01 ; Barcode type **k** = EAN-8  
02 ; Module width **m** = 2 dots / 180 inch  
00 ; Space adjustment value **s** = +0 dots / 360 inch  
7D 00 ; Bar length **v1**, **v2** = 125 / 180 inch  
03 ; Control flags **c**  
30 31 32 33 34 35 36 ; Barcode Data

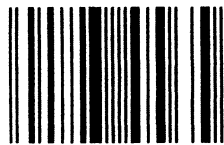

example 6: Interleaved 2 of 5, CD: Host, HRI: print

1B 28 42 1A 00 ; Barcode command and data length  
02 ; Barcode type **k** = Interleaved 2 of 5  
02 ; Module width **m** = 2 dots / 180 inch  
00 ; Space adjustment value **s** = +0 dots / 360 inch  
7D 00 ; Bar length **v1**, **v2** = 125 / 180 inch  
00 ; Control flags **c**  
31 32 33 34 35 36 37 ; Barcode Data  
38 39 30 31 32 33 34 ;  
35 36 37 38 39 30 ;



example 7: Interleaved 2 of 5, CD: Printer, HRI: none

1B 28 42 19 00 ; Barcode command and data length  
02 ; Barcode type **k** = Interleaved 2 of 5  
02 ; Module width **m** = 2 dots / 180 inch  
00 ; Space adjustment value **s** = +0 dots / 360 inch  
7D 00 ; Bar length **v1, v2** = 125 / 180 inch  
03 ; Control flags **c**  
31 32 33 34 35 36 37 ; Barcode Data  
38 39 30 31 32 33 34 ;  
35 36 37 38 39 ;

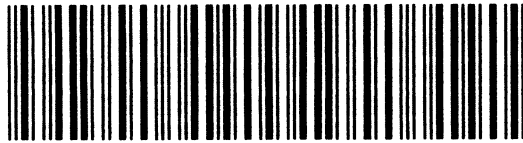

example 8: Interleaved 2 of 5, CD: Host, HRI: print

Next example is that '0' is added automatically, in the case that the data number is odd.

1B 28 42 19 00 ; Barcode command and data length  
02 ; Barcode type **k** = Interleaved 2 of 5  
02 ; Module width **m** = 2 dots / 180 inch  
00 ; Space adjustment value **s** = +0 dots / 360 inch  
7D 00 ; Bar length **v1, v2** = 125 / 180 inch  
00 ; Control flags **c**  
31 32 33 34 35 36 37 ; Barcode Data  
38 39 30 31 32 33 34 ;  
35 36 37 38 39 ;



0 1 2 3 4 5 6 7 8 9 0 1 2 3 4 5 6 7 8 9

example 9: UPC-A, CD: Host, HRI: Print, Flag Char.: center

1B 28 42 12 00 ; Barcode command and data length  
03 ; Barcode type **k** = UPC-A  
02 ; Module width **m** = 2 dots / 180 inch  
00 ; Space adjustment value **s** = +0 dots / 360 inch  
7D 00 ; Bar length **v1, v2** = 125 / 180 inch  
00 ; Control flags **c**  
30 31 32 33 34 35 36 ; Barcode Data  
37 38 39 30 35 ;



example 10: UPC-A, CD: Printer, HRI: print, Flag Char.: under  
 1B 28 42 11 00 ; Barcode command and data length  
 03 ; Barcode type **k** = UPC-A  
 02 ; Module width **m** = 2 dots / 180 inch  
 00 ; Space adjustment value **s** = +0 dots / 360 inch  
 7D 00 ; Bar length **v1, v2** = 125 / 180 inch  
 05 ; Control flags **c**  
 31 32 33 34 35 36 ; Barcode Data  
 37 38 39 30 31 ;



example 11: UPC-A, CD: Printer, HRI: none, Flag Char.: center  
 1B 28 42 11 00 ; Barcode command and data length  
 03 ; Barcode type **k** = UPC-A  
 02 ; Module width **m** = 2 dots / 180 inch  
 00 ; Space adjustment value **s** = +0 dots / 360 inch  
 7D 00 ; Bar length **v1, v2** = 125 / 180 inch  
 03 ; Control flags **c**  
 31 32 33 34 35 36 ; Barcode Data  
 37 38 39 30 31 ;

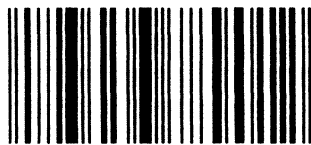

example 12: UPC-E, CD: Host, HRI: print  
 Next example is that of barcode data compacted in accordance with specifications by the printer.

1B 28 42 12 00 ; Barcode command and data length  
 04 ; Barcode type **k** = UPC-E  
 02 ; Module width **m** = 2 dots / 180 inch  
 00 ; Space adjustment value **s** = +0 dots / 360 inch  
 7D 00 ; Bar length **v1, v2** = 125 / 180 inch  
 00 ; Control flags **c**  
 30 31 32 33 34 35 36 ; Barcode Data  
 37 38 39 30 35 ;



example 13: UPC-E, CD: Printer, HRI: none

Next example is that of the barcode data compacted in accordance with specifications by the printer.

1B 28 42 11 00 ; Barcode command and data length  
04 ; Barcode type **k** = UPC-E  
02 ; Module width **m** = 2 dots / 180 inch  
00 ; Space adjustment value **s** = +0 dots / 360 inch  
7D 00 ; Bar length **v1**, **v2** = 125 / 180 inch  
03 ; Control flags **c**  
31 32 33 34 35 36 ; Barcode Data  
37 38 39 30 31 ;

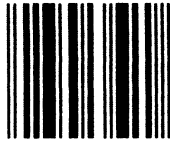

example 14: UPC-E, CD: Host, HRI: print

1B 28 42 0E 00 ; Barcode command and data length  
04 ; Barcode type **k** = UPC-E  
02 ; Module width **m** = 2 dots / 180 inch  
00 ; Space adjustment value **s** = +0 dots / 360 inch  
7D 00 ; Bar length **v1**, **v2** = 125 / 180 inch  
00 ; Control flags **c**  
30 31 32 33 34 35 ; Barcode Data  
30 33 ;



example 15: UPC-E, CD: Printer, HRI: print

1B 28 42 0D 00 ; Barcode command and data length  
04 ; Barcode type **k** = UPC-E  
02 ; Module width **m** = 2 dots / 180 inch  
00 ; Space adjustment value **s** = +0 dots / 360 inch  
7D 00 ; Bar length **v1**, **v2** = 125 / 180 inch  
01 ; Control flags **c**  
30 31 32 33 34 35 30 ; Barcode Data



example 16: UPC-E, CD: printer, HRI: none

1B 28 42 0D 00 ; Barcode command and data length  
04 ; Barcode type **k** = UPC-E  
02 ; Module width **m** = 2 dots / 180 inch  
00 ; Space adjustment value **s** = +0 dots / 360 inch  
7D 00 ; Bar length **v1**, **v2** = 125 / 180 inch  
03 ; Control flags **c**  
30 31 32 33 34 35 30 ; Barcode Data

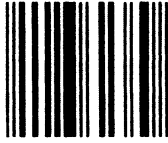

example 17: Code 39, CD: host, HRI: print

1B 28 42 0D 00 ; Barcode command and data length  
05 ; Barcode type **k** = Code 39  
02 ; Module width **m** = 2 dots / 180 inch  
00 ; Space adjustment value **s** = +0 dots / 360 inch  
7D 00 ; Bar length **v1**, **v2** = 125 / 180 inch  
00 ; Control flags **c**  
31 32 41 42 24 25 2E ; Barcode Data



example 18: Code 39, CD: Printer, HRI: print

1B 28 42 0D 00 ; Barcode command and data length  
05 ; Barcode type **k** = Code 39  
02 ; Module width **m** = 2 dots / 180 inch  
00 ; Space adjustment value **s** = +0 dots / 360 inch  
7D 00 ; Bar length **v1**, **v2** = 125 / 180 inch  
01 ; Control flags **c**  
31 32 41 42 24 25 2E ; Barcode Data



example 19: Code 39, CD: Printer, HRI: none

1B 28 42 0D 00 ; Barcode command and data length  
05 ; Barcode type **k** = Code 39  
02 ; Module width **m** = 2 dots / 180 inch  
00 ; Space adjustment value **s** = +0 dots / 360 inch  
7D 00 ; Bar length **v1**, **v2** = 125 / 180 inch  
03 ; Control flags **c**  
31 32 41 42 24 25 2E ; Barcode Data



example 20: Code 128, CD: Printer, HRI: print, using Data Character Set A

1B 28 42 10 00 ; Barcode command and data length  
06 ; Barcode type **k** = Code 128  
02 ; Module width **m** = 2 dots / 180 inch  
00 ; Space adjustment value **s** = +0 dots / 360 inch  
7D 00 ; Bar length **v1**, **v2** = 125 / 180 inch  
01 ; Control flags **c**  
41 32 33 40 41 21 43 ; Barcode Data  
44 5B 5D ;



2 3 @ A ! C D [ ] 5

example 21: Code 128, CD: Printer, HRI: print, using Data Character Set B

1B 28 42 10 00 ; Barcode command and data length  
06 ; Barcode type **k** = Code 128  
02 ; Module width **m** = 2 dots / 180 inch  
00 ; Space adjustment value **s** = +0 dots / 360 inch  
7D 00 ; Bar length **v1**, **v2** = 125 / 180 inch  
01 ; Control flags **c**  
42 32 33 40 61 42 63 ; Barcode Data  
44 5B 5D ;



2 3 @ a B c D [ ] Δ

example 22: Code 128, CD: Host, HRI: none, using Data Character Set B

1B 28 42 10 00 ; Barcode command and data length  
06 ; Barcode type **k** = Code 128  
02 ; Module width **m** = 2 dots / 180 inch  
00 ; Space adjustment value **s** = +0 dots / 360 inch  
7D 00 ; Bar length **v1**, **v2** = 125 / 180 inch  
02 ; Control flags **c**  
42 32 33 40 61 42 63 ; Barcode Data  
44 5B 5D ;



example 23: Code 128, CD: Host, HRI: print, using Data Character Set C

1B 28 42 11 00 ; Barcode command and data length  
06 ; Barcode type **k** = Code 128  
02 ; Module width **m** = 2 dots / 180 inch  
00 ; Space adjustment value **s** = +0 dots / 360 inch  
7D 00 ; Bar length **v1**, **v2** = 125 / 180 inch  
00 ; Control flags **c**  
43 30 31 32 33 34 35 ; Barcode Data  
36 37 38 39 ;

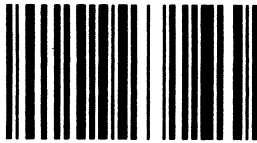

0123456789

example 24: Code 128, CD: Host, HRI: print, using Data Character Set C

Next example is of '0' added automatically, in the case of odd-numbered data.

1B 28 42 10 00 ; Barcode command and data length  
06 ; Barcode type **k** = Code 128  
02 ; Module width **m** = 2 dots / 180 inch  
00 ; Space adjustment value **s** = +0 dots / 360 inch  
7D 00 ; Bar length **v1**, **v2** = 125 / 180 inch  
00 ; Control flags **c**  
43 31 32 33 34 35 ; Barcode Data  
36 37 38 39 ;



0123456789

example 25: Code 128, CD: Host, HRI: print, mixed Data Character Set A, B and C

1B 28 42 14 00 ; Barcode command and data length  
06 ; Barcode type **k** = Code 128  
02 ; Module width **m** = 2 dots / 180 inch  
00 ; Space adjustment value **s** = +0 dots / 360 inch  
7D 00 ; Bar length **v1**, **v2** = 125 / 180 inch  
00 ; Control flags **c**  
41 30 62 61 64 70 1C ; Barcode Data  
37 39 3A 62 1B 3D 61 ;

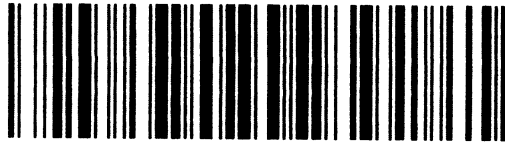

0 a p 79 b = a

example 26: POSTNET, CD: Host

1B 28 42 10 00 ; Barcode command and data length  
07 ; Barcode type **k** = POSTNET  
02 ; Module width **m** = 2 dots / 180 inch  
00 ; Space adjustment value **s** = +0 dots / 360 inch  
00 00 ; Bar length value **v1** and **v2** are ignored. POSTNET  
uses the fixed bar length.  
00 ; Control flags **c**  
31 32 33 34 35 36 37 ; Barcode Data  
38 39 30



example 27: POSTNET, CD: Printer

1B 28 42 0F 00 ; Barcode command and data length  
07 ; Barcode type **k** = POSTNET  
02 ; Module width **m** = 2 dots / 180 inch  
00 ; Space adjustment value **s** = +0 dots / 360 inch  
00 00 ; Bar length value **v1** and **v2** are ignored. POSTNET  
uses the fixed bar length.  
01 ; Control flags **c**  
31 32 33 34 35 36 37 ; Barcode Data  
38 39



## Extended ESC/P 2 Programming Guide

To accommodate the high-resolution color graphics available to the Stylus COLOR and later inkjet printer models, EPSON has expanded the ESC/P 2 command set. The Stylus COLOR and later high-resolution ink jet printers are fully EPSON ESC/P 2 compliant. They support four multipoint fonts, the new MicroWeave command, and four raster graphics modes:

### *Standard raster graphics*

Uncompressed raster graphics printing (ESC . 0)

Compressed raster graphics—Run Length Encoding (RLE) (ESC . 1)

### *Extended raster graphics (Stylus COLOR and later inkjet models only)*

Compressed raster graphics—TIFF (ESC . 2)

To select one of these four raster graphics modes, set the *c* parameter in the print raster graphics command ESC . *c* *v* *h* *m* *n<sub>L</sub>* *n<sub>H</sub>* *d<sub>1</sub>* . . . *d<sub>k</sub>* as follows:

<i>c</i>	<i>mode</i>
0	Uncompressed raster graphics
1	RLE compression
2	TIFF compression

The TIFF mode command is only implemented in the Stylus COLOR and later inkjet model printers. These commands also make use of a subset of binary mode commands new to the ESC/P 2 command language. The Stylus COLOR is, of course, backward compatible with the ESC/P command language. To make full use of the new commands and features supported by the Stylus COLOR, we suggest writing an ESC/P 2 color printer driver specifically for this model. In addition, all future color printers, both ink jets and SIDMs, will include the expanded ESC/P 2 commands. By incorporating a new color printer driver in your application, you will be able to take full advantage of the program's powerful color features when printing with EPSON's high-resolution printers.

## *MicroWeave technology*

The MicroWeave feature added to the ESC/P 2 command set reduces the banding—uniform horizontal lines in graphics—usually associated with serial printers. The command syntax is ESC ( *i* 01 00 *n*, where *n* = 0 MicroWeave off (default), and *n* = 1 MicroWeave on. Banding is caused by the misalignment of printed dots at the boundary of two adjacent raster bands owing to mechanical limitations of the printer. MicroWeave technology compensates for these limitations by moving the print head in smaller vertical increments than the height of a non-MicroWeave raster band and firing the nozzles in a staggered sequence. This process shortens the band heights, making them less distinct.

To use MicroWeave, the band height (*m*) in the ESC . command must be set to 1. This feature also increases printing time, but it completely eliminates banding and yields sharp, near photographic-quality color images. For more information about this command, see its description in Individual Command Explanations.

## *Monochrome printing support*

Black and white printing support for the Stylus COLOR can be achieved most easily by renaming an existing ESC/P 2 monochrome driver. The ESC/P 2 command language implements four scalable multipoint fonts: Roman, Sans Serif, Roman T, and Sans Serif H not available to ESC/P printers. In addition, ESC/P 2 printers support compressed graphics printing. In the monochrome multipoint mode, the Stylus COLOR printer supports the same four multipoint fonts available to current EPSON ESC/P 2 printers, including the LQ-150 (ActionPrinter 3260), LQ-570+ (ActionPrinter 5000+), LQ-1070+, Stylus 400, Stylus 800+, Stylus 1000, Stylus 800, and Stylus 300. However, in order to access the new extended raster graphics compressed modes, the driver should incorporate the latest ESC/P 2 commands, including ESC . 2.

## *Color bit-image graphics support*

The best way to support color printing on the Stylus COLOR is to write a new driver that includes all of the expanded ESC/P 2 commands available to the Stylus COLOR and other high-resolution EPSON printers. A simpler although less desirable method of supporting color printing would be to rename an existing ESC/P color driver. Driver examples include the LQ-860 or LQ-2550. This method would support the Stylus COLOR as an older ESC/P bit-image printer but would seriously limit its high-resolution printing capabilities and deny access to other advanced features such as multipoint fonts, raster graphics data compression (RLE or TIFF), and MicroWeave.

## *ESC/P 2 color multipoint font support*

Color multipoint font ESC/P 2 drivers can be developed by adding the select print color command (ESC r n) to existing black and white ESC/P 2 drivers. In multipoint mode, insert the select print color command using the values below.

<i>n</i>	<i>color</i>
0	Black (default)
1	Magenta
2	Cyan
3	Violet
4	Yellow
5	Red
6	Green

The Stylus COLOR uses process color inks—Cyan, Magenta, Yellow, and Black (CMYK)—to produce other colors, including Violet, Red, and Green. Existing printer drivers that can be modified to support color multipoint fonts are the LQ-150 (ActionPrinter 3260), LQ-570+ (ActionPrinter 5000+), LQ-1070+, Stylus 400, Stylus 800+, Stylus 1000, Stylus 800, and Stylus 300. For more information, see programming Example 1: ESC/P 2 color multipoint font driver. Also see the ESC r command description in Individual Command Explanations.

## *ESC/P 2 MicroWeave color raster graphics and RLE compressed raster graphics*

Color raster graphics printing with MicroWeave requires the addition of the MicroWeave command “ESC ( i 01 00 n” and the select color command “ESC r n” to an existing monochrome raster graphics driver. Only four colors are available when printing raster graphics.

<i>n</i>	<i>color</i>
0	Black (default)
1	Magenta
2	Cyan
4	Yellow

### **Note:**

If you change the selected colors after entering raster graphics mode, the data buffer will be flushed.

Any of the following printer drivers can be modified to support MicroWeave color raster graphics printing: Stylus 400, Stylus 800+, Stylus 1000, Stylus 800, Stylus 300, LQ-570+ (ActionPrinter 5000+), LQ-1070+, LQ-150 (ActionPrinter 3260), and LQ-100 (ActionPrinter 3250). This mode can access the highest printing resolution (720 by 720 dpi) featured on EPSON’s latest color ink jet printers, such as the Stylus COLOR. See Example 2: MicroWeave ESC/P 2 color raster graphics and RLE compressed raster graphics driver for more information.

## *ESC/P 2 MicroWeave color extended raster graphics—TIFF*

With the introduction of the Stylus COLOR, new compression method—TIFF—has been added to the existing ESC/P 2 graphics command set. To enter TIFF compressed mode, select the ESC . 2 extended raster graphics command. This compression architecture saves up to five bytes of overhead per raster line.

### **Note:**

In TIFF compressed mode, the band height (m) must always be set to 1. In this setting, one raster line prints at a time.

The new compression mode supports the Stylus COLOR’s and later inkjet printers’ maximum resolution of 720 by 720 dpi and MicroWeave. The ESC . 2 extended raster graphics compression commands make use of a subset of binary mode commands new to ESC/P 2. These commands, which reduce the amount of code data that must be sent to the printer, are explained below.

## Binary mode commands

The following binary commands are applicable to the TIFF compressed mode. All other commands are ignored after entering extended raster graphics.

<XFER>	Transfer raster graphics data
<MOVX>	Set relative horizontal position
<MOVY>	Set relative vertical position
<COLR>	Select printing color
<CR>	Carriage return to left-most print position
<EXIT>	Exit TIFF compressed mode
<MOVXBYTE>	Set <MOVX> unit to 8 dots
<MOVXDOT>	Set <MOVX> unit to 1 dot

The binary mode commands are divided into three classes:

<i>Class</i>	<i>Description</i>
1	command without parameter
2	command with parameter
3	command with parameter and data

## Bit assignments

Bit assignments for the binary mode commands are as follows:

### *Class 1 commands (without parameter)*

Bits 0–3	Command ID
Bit 4	Flag bit
Bits 5–7	Opcode

### *Class 2 commands (with parameter)*

Bits 0–3	Parameter or counter
Bit 4	Flag bit
Bits 5–7	Opcode

### *Class 3 commands (with parameter and data)*

Bits 0–3	Definition changes based on bit 4
Bit 4 = 0	Bits 0–3 are twos complement parameter
Bit 4 = 1	Bits 0–3 are parameter byte count
Bits 5–7	Opcode

*System level commands*

Class	Command	High nibble	Low nibble	Description
1	<CR>	1110	0010	Move to left most position (x = 0)
1	<EXIT>	1110	0011	Exit TIFF binary mode
1	<MOVXBYTE>	1110	0100	Horizontal (x) moves are in bytes
1	<MOVDOT>	1110	0101	Horizontal (x) moves are in dots

*Movement commands*

Class	Command	High nibble	Low nibble	Description
2	<MOVX>	0100	Count	Move -8 to +7 units (dots/bytes), default is dots
2	<MOVX>	0101	#BC	Move ±# units (dots/bytes), default is dots
2	<MOVY>	0110	Count	Move 0 to 15 units
2	<MOVY>	0111	#BC	Move # units

*Graphics commands*

Class	Command	High nibble	Low nibble	Description
3	<XFER>	0010	Count	Transfer 1–15 bytes of graphics data
3	<XFER>	0011	#BC	Transfer # bytes of graphics data
3	<COLR>	1000	Color	C,M,Y,K = 2, 1, 4, 0

**Note:**

When the color setting is changed with the <COLR> command, the print head moves to the left-most position (x = 0).

See Example 3 and the following feature comparison table for further information.

*EPSON ESC/P Printer Feature Comparison Table*

	Stylus COLOR	LQ-150 (AP-3260)	LQ-570+ (AP-5000+)	LQ-860/LQ-2550	Stylus 300/800/1000
Serial Printer Technology	112 nozzle ink jet	24-pin impact	24-pin impact	24-pin impact	24-nozzle ink jet
Multipoint Fonts	4	4	4	0	4
Compressed Raster Graphics	TIFF, RLE	RLE	RLE	None	RLE
Color	Yes	Yes	No	Yes	No
MicroWeave	Yes	No	No	No	No
Max. Resolution (dpi) Color/Mono	720 × 720/ 720 × 720	360 × 180/ 360 × 360	N/A/360 × 360	360 × 180/ 360 × 360	N/A/ 360 × 360
Top/Bottom Margins	3/13 mm	5.3/9 mm	5.3/9 mm	8.5/13.5 mm	3/13 mm

**Note:**

Color printing is not available with the LQ-570+ (AP-5000+), Stylus 300, Stylus 400, Stylus 800, Stylus 800+, and Stylus 1000.

## Programming examples

This section provides several programming examples that take advantage of the new features of the Stylus COLOR and later printer models. The following examples are not inclusive. Therefore, the specific driver commands you use will depend on the application.

### Example 1: ESC/P 2 color multipoint font driver

#### Step 1 Start Job

ESC @ initialize the printer, reset printer to defaults

#### Step 2 Set Specific Configuration

ESC ( U set units  
ESC ( t assign character table  
ESC ( C set page length in defined unit—continuous paper only  
ESC ( c set page format—top and bottom margins  
ESC X set pitch before setting left and right margins (ESC P, ESC M, ESC g)  
ESC l & ESC Q set left and right margins  
ESC = set line spacing  $n/360$ "

#### Step 3 Adjust Vertical Print Position (if necessary)

ESC ( V absolute position in units  
ESC ( v relative position in units  
LF line feed  
FF form feed

#### Step 4 Adjust Horizontal Print Position (if necessary)

ESC \$ absolute position in units  
ESC \ relative position in units  
CR carriage return

#### Step 5 Output Text

ESC r n select printing color  
where n = 0 Black  
1 Magenta  
2 Cyan  
3 Violet  
4 Yellow  
5 Red  
6 Green

ESC t	select character table
ESC X	select font by pitch and point—multipoint mode
ESC k	select typeface (see ESC k command description for latest font parameters)
ESC 4 & ESC 5	italic on/off
ESC E & ESC F	bold on/off
ESC (-	select line/score
ESC q	character style—outline/shadow

Send data to be printed

Repeat as necessary within line

Signal end of line—use CR, LF, or vertical positioning

### Step 6 Repeat Above as Necessary within Page

### Step 7 End Page

Send FF command

Prompt user for paper if in single-sheet mode

### Step 8 End Job

ESC @            reset printer to defaults

*Example 2: MicroWeave ESC/P 2 standard color raster graphics and RLE compressed raster graphics driver*

### Step 1 Start Job

ESC @            initialize the printer, reset printer to defaults

### Step 2 Enter Raster Graphics Mode

ESC ( G            select graphics mode

**Note:**

- The appropriate driver commands depend on the application.
- New or expanded ESC/P 2 commands are shown in bold.

### Step 3 Set Specific Configuration

ESC ( i 01 00 n    turn MicroWeave on/off  
                           where    n = 0 MicroWeave off  
   1 MicroWeave on

**Note:**

- If the EPSON ESC/P 2 printer does not support MicroWeave, it will ignore the ESC ( i command. High-resolution color printers, including the Stylus COLOR, support MicroWeave.
- Execute the ESC ( i command prior to paper feed.

ESC ( U	set units
ESC ( C	set page length in defined unit—continuous paper only
ESC ( c	set page format—top and bottom margins
ESC U	turn unidirectional mode on/off

#### **Adjust Vertical Print Position (if necessary)**

ESC ( V	absolute position in units
ESC ( v	relative position in units
LF	line feed
FF	form feed

#### **Step 4 Adjust Horizontal Print Position (if necessary)**

ESC \$	absolute position in units
ESC \	relative position in units
CR	carriage return

#### **Step 5 Output Raster Graphics**

ESC \	relative horizontal position in units
ESC r n	select printing color
	where n = 0 Black
	1 Magenta
	2 Cyan
	4 Yellow
ESC .c	print raster graphics data
	where c = 0 uncompressed raster graphics
	1 compressed raster graphics (RLE)

#### **Note:**

Use data compression whenever possible to reduce file size and printing time.

CR	carriage return
----	-----------------

Repeat steps as necessary within a graphics block—start with yellow and then follow command sequence with magenta, cyan, and black. If necessary, signal the end of the graphics band with a CR, LF, or vertical positioning command.

#### **Step 6 Repeat Above as Necessary within Page**

Send FF command  
 Prompt user for paper if in single-sheet mode

#### **Step 7 End Job**

ESC @	reset printer to defaults (exit raster graphics mode)
-------	---

*Example 3: MicroWeave ESC/P 2 extended color raster graphics and TIFF compressed raster graphics driver*

**Step 1 Start Job**

Send ESC @ to initialize the printer, reset printer to defaults

**Step 2 Enter Raster Graphics Mode**

Send ESC ( G to select graphics mode

**Note:**

- The appropriate driver commands depend on the application.
- New or expanded ESC/P 2 commands are shown in bold.

**Step 3 Set Specific Configuration**

Send ESC ( i 01 00 n to turn MicroWeave on/off  
where n = 0 MicroWeave off  
1 MicroWeave on

**Note:**

- If the EPSON ESC/P 2 printer does not support MicroWeave, it will ignore the command. The Stylus COLOR supports MicroWeave.
- Execute the ESC ( i command prior to paper feed.

Send:

ESC ( U to set units  
ESC ( C to set page length in defined unit—continuous paper only  
ESC ( c to set page format—top and bottom margins  
ESC U to turn unidirectional mode on/off

**Step 4 Enter TIFF Raster Graphics Mode**

Send ESC . 2 to enter TIFF compressed raster graphics mode

**Note:**

Only binary commands can be used after entering TIFF compressed mode.

Send <**MOVXDOT**> or <**MOVXBYTE**> to set horizontal move units to one dot or eight dots (1 byte)

Send <**MOVY**> to move vertically to first line of the image block  
Send <**COLR**> to select color (Black, Magenta, Cyan, or Yellow)  
Send <**MOVX**> or <**CR**> to move horizontally to first part of image block  
Send <**XFER**> to send TIFF raster graphics data  
Repeat as necessary for the existing line of the image block.  
Repeat as necessary for the existing image block

**Step 5 Repeat Above as Necessary within Page**

**Step 6 End Page**

Send **<EXIT>** to exit TIFF compressed raster graphics mode  
Send FF command—eject paper  
Prompt user for paper if in single-sheet mode

**Step 7 Repeat Above as Necessary for the Job**

**Step 8 End Job**

Send ESC @ to reset printer to defaults (exit raster graphics mode)

*TIFF mode programming sequence*

